

**SELECT FIXED SERIES  
SELECT VARIABLE SERIES  
PERISTALTIC METERING PUMPS**

---

**INSTALLATION AND MAINTENANCE MANUAL**

 **WARNING**

TO BE INSTALLED AND MAINTAINED BY PROPERLY TRAINED  
PROFESSIONAL INSTALLER ONLY. READ MANUAL & LABELS  
FOR ALL SAFETY INFORMATION & INSTRUCTIONS.

# TABLE OF CONTENTS

<b>WARRANTY AND SERVICE POLICY .....</b>	<b>3</b>
<b>SAFETY INSTRUCTIONS.....</b>	<b>4-5, 12-15, 18, 20-21, 23-27, 30, 35, 43</b>
<b>FLOW RATE OUTPUTS .....</b>	<b>6-7</b>
<b>MATERIALS OF CONSTRUCTION.....</b>	<b>8</b>
<b>ACCESSORIES.....</b>	<b>9</b>
<b>OPERATION .....</b>	<b>10-11</b>
<b>CONNECTIONS .....</b>	<b>12-16</b>
<b>SETTINGS .....</b>	<b>17-19</b>
<b>INSTALLATION.....</b>	<b>20-26</b>
<b>TROUBLESHOOTING.....</b>	<b>27-29</b>
<b>TUBE REPLACEMENT.....</b>	<b>30-34</b>
<b>CLEANING THE POINT OF INJECTION .....</b>	<b>35-37</b>
<b>PARTS .....</b>	<b>38-42</b>
<b>CHEMICAL RESISTANCE GUIDE.....</b>	<b>43-46</b>
<b>WALL MOUNT BRACKET DIMENSIONS .....</b>	<b>47</b>

IMSFV 010120a

# WARRANTY AND CUSTOMER SERVICE

## LIMITED WARRANTY

Stenner Pump Company will for a period of two (2) years from the date of purchase (proof of purchase required) repair or replace at our option all defective parts. Stenner is not responsible for any removal or installation costs. Pump tube assemblies and rubber components are considered perishable and are not covered in this warranty. Pump tube will be replaced each time a pump is in for service, unless otherwise specified. The cost of the pump tube replacement will be the responsibility of the customer. Stenner will incur shipping costs for warranty products shipped from our factory in Jacksonville, Florida. Any tampering with major components, chemical damage, faulty wiring, weather conditions, water damage, power surges, or products not used with reasonable care and maintained in accordance with the instructions will void the warranty. Stenner limits its liability solely to the cost of the original product. We make no other warranty expressed or implied.

## RETURNS

Stenner offers a 30-day return policy on factory direct purchases. Except as otherwise provided, no merchandise will be accepted for return after 30 days from purchase. To return merchandise at any time, call Stenner at 800.683.2378 for a Return Merchandise Authorization (RMA) number. A 15% re-stocking fee will be applied. Include a copy of your invoice or packing slip with your return.

## DAMAGED OR LOST SHIPMENTS

Check your order immediately upon arrival. All damage must be noted on the delivery receipt. Call Stenner Customer Service at 800.683.2378 for all shortages and damages within seven (7) days of receipt.

## SERVICE & REPAIRS

Before returning a pump for warranty or repair, remove chemical from pump tube by running water through the tube, and then run the pump dry. Following expiration of the warranty period, Stenner Pump Company will clean and overhaul any Stenner metering pump for a minimum labor charge plus necessary replacement parts and shipping. All metering pumps received for overhaul will be restored to their original condition. The customer will be charged for missing parts unless specific instructions are given. To return merchandise for repair, call Stenner at 800.683.2378 or 904.641.1666 for a Return Merchandise Authorization (RMA) number.

## DISCLAIMER

The information contained in this manual is not intended for specific application purposes. Stenner Pump Company reserves the right to make changes to prices, products, and specifications at any time without prior notice.

## TRADEMARKS

QuickPro® is a registered trademark of the Stenner Pump Company.  
Santoprene® is a registered trademark of Exxon Mobil Corporation.  
Versilon® is a registered trademark of Saint-Gobain Performance Plastics.  
Pellethane® is a registered trademark of Lubrizol Advanced Materials, Inc.  
Hastelloy® is a registered trademark of Haynes International, Inc.  
AquaShield™ is a trademark of Houghton International.

# SAFETY INFORMATION

## IMPORTANT SAFETY INSTRUCTIONS

When installing and using this electrical equipment, basic safety precautions should always be followed, including the following:

### READ AND FOLLOW ALL INSTRUCTIONS

 **⚠ WARNING** Warns about hazards that CAN cause death, serious personal injury, or property damage if ignored.

 **⚠ WARNING** ELECTRIC SHOCK HAZARD

 **⚠ WARNING** RISK OF ELECTRIC SHOCK

Connect only to a branch circuit protected by a ground-fault circuit-interrupter (GFCI). Contact a qualified electrician if you cannot verify that the receptacle is protected by a GFCI.

 **⚠ AVERTISSEMENT** RISQUE DE CHOC ELECTRIQUE

Brancher seulement à un réseau électrique protégé par un DDFT. Contactez un électricien certifié si vous ne pouvez pas vérifier que la prise est protégé par un DDFT.

 **⚠ PELIGRO** PELIGRO DE DESCARGA ELECTRICA

Conecte a un circuito en derivación protegido por un interruptor de descarga a tierra (GFCI). Contacte a un electricista certificado si no puede verificar que su receptáculo esté protegido por dicho interruptor (GFCI).

 **⚠ WARNING** To reduce the risk of electric shock, replace damaged cord immediately. Contact the factory or an authorized service facility for repair.

 **⚠ WARNING** DO NOT alter the power cord or plug end. DO NOT use receptacle adapters.

 **⚠ WARNING** DO NOT use pump with a damaged or altered power cord or plug. Contact the factory or authorized service facility for repair.

 **⚠ WARNING** After installation, the power supply plug must be accessible during use.

 **⚠ WARNING** To reduce the risk of injury, DO NOT permit children to use this product. This appliance is not to be used by persons with reduced physical, sensory or mental capabilities, or lack of experience and knowledge, unless they have been given supervision or instruction.

 **⚠ WARNING** This pump has not been investigated for use in marine areas.

 **⚠ AVERTISSEMENT** La pompe n'a pas été vérifiée et approuvée pour utilisation sur des applications de installation marine.

 **⚠ PELIGRO** Este dosificador no ha sido investigado para uso en áreas marinas.

 **⚠ WARNING** EXPLOSION HAZARD

This equipment IS NOT explosion proof. DO NOT install in an explosive environment.

 **⚠ WARNING** RISK OF CHEMICAL EXPOSURE AND OVERDOSE

Potential for chemical burns, fire, explosion, personal injury, or property damage. To reduce risk of exposure, the use of proper personal protective equipment is mandatory. To reduce risk of overdosing, follow proper installation methods and recommendations. Check your local codes for additional guidelines.









 **⚠ WARNING** RISK OF FIRE HAZARD

DO NOT install or operate on any flammable surface.

 **⚠ WARNING** Pump is not recommended for installation in areas where leakage can cause personal injury or property damage.









# SAFETY INSTRUCTIONS

 **CAUTION** Warns about hazards that WILL or CAN cause minor personal injury or property damage if ignored.

-  **CAUTION** To reduce risk of electric shock, pull plug before servicing this pump.
-  **CAUTION** This pump has been evaluated for use with water only.
-  **CAUTION** Non-submersible pump. Suitable for indoor and outdoor use.
-  **ATTENTION** Pompe non submersible. Adaptée à une utilisation aussi bien à l'intérieur qu'à l'extérieur.
-  **CUIDADO** Dosificador no sumergible. Adecuado para el uso interior y exterior.
-  **CAUTION PLUMBING**  
Chemical feed pump installation must always adhere to your local plumbing codes and requirements. Be sure installation does not constitute a cross connection. Check local plumbing codes for guidelines.
-  **CAUTION** Electrical installation should adhere to all national and local codes. Consult licensed professional for assistance with proper electrical installation.
-  **CAUTION** Pump uses a class 2 switching power supply.

## SAVE THESE INSTRUCTIONS

 **CAUTION NOTICE:** Indicates special instructions or general mandatory action.

-  This metering pump is portable and designed to be removable from the plumbing system without damage to the connections.
-  This metering pump and its components have been tested for use with the following chemicals; Sodium Hypochlorite (10-15%), Muriatic Acid (20-22 Baume, 31.5% Hcl), and Soda Ash.
-  Cette a pompe de dosage et ses composants ont été testés pour utilisation avec les produits chimiques suivants; Hypochlorite de Sodium (solution de 10-15%); Acide Muriatique (20-22 Baume, 31.5% Hcl); Cendre de Soude.
-  Before installing or servicing the pump, read the pump manual for all safety information and complete instructions. The pump is designed for installation and service by properly trained personnel.
-  No user replaceable parts inside.
-  DO NOT install at altitudes over 2000 meters.
-  The ambient temperature rating is 104°F (40°C).
-  DO NOT cycle the pump on and off via mains power more than 4 times per minute.

# FLOW RATE OUTPUTS – FIXED

## S3F Models

### 25 psi (1.7 bar) max.

Item No. Prefix	Pump Tube	Gallons per Day	Gallons per Hour	Ounces per Hour	Ounces per Min.	Liters per Day	Liters per Hour	Milliliters per Hour	Milliliters per Min.
S3F03	3	40.0	1.67	213.0	3.56	151.0	6.31	6309.0	105.0
S3F04	4	60.0	2.50	320.0	5.33	227.0	9.46	9464.0	158.0
S3F05	5	85.0	3.54	453.0	7.56	322.0	13.41	13407.0	223.0

Approximate Outputs @ 50/60Hz

### 100 psi (6.9 bar) max.

Item No. Prefix	Pump Tube	Gallons per Day	Gallons per Hour	Ounces per Hour	Ounces per Min.	Liters per Day	Liters per Hour	Milliliters per Hour	Milliliters per Min.
S3F01	1	5.0	0.21	27.0	0.44	19.0	0.79	789.0	13.0
S3F02	2	17.0	0.71	91.0	1.51	64.0	2.68	2681.0	45.0
S3F07	7	40.0	1.67	213.0	3.56	151.0	6.31	6309.0	105.0

Approximate Outputs @ 50/60Hz

## S4F Models

### 25 psi (1.7 bar) max.

Item No. Prefix	Pump Tube	Gallons per Day	Gallons per Hour	Ounces per Hour	Ounces per Min.	Liters per Day	Liters per Hour	Milliliters per Hour	Milliliters per Min.
S4F5X	5X	150.0	6.25	800.0	13.33	567.0	23.66	23658.0	394.0

Approximate Outputs @ 50/60Hz

### 100 psi (6.9 bar) max.

Item No. Prefix	Pump Tube	Gallons per Day	Gallons per Hour	Ounces per Hour	Ounces per Min.	Liters per Day	Liters per Hour	Milliliters per Hour	Milliliters per Min.
S4F7X	7X	60.0	2.50	320.0	5.33	227.0	9.46	9464.0	158.0

Approximate Outputs @ 50/60Hz



**NOTICE:** The information within this chart is solely intended for use as a guide. The output data is an approximation based on pumping water under a controlled testing environment. Many variables can affect the output of the pump. Stenner Pump Company recommends that all metering pumps undergo field calibration by means of analytical testing to confirm their outputs.

# FLOW RATE OUTPUTS – VARIABLE

## S3V Models

### 25 psi (1.7 bar) max.

Item No. Prefix	Pump Tube	Turndown Ratio	Gallons per Day	Gallons per Hour	Ounces per Hour	Ounces per Min.	Liters per Day	Liters per Hour	Milliliters per Hour	Milliliters per Min.
S3V03	3	10:1	4.0-40.0	0.17-1.67	21.3-213.0	0.36-3.56	15.1-151.0	0.63-6.31	630.9-6309.0	10.5-105.0
S3V04	4	10:1	6.0-60.0	0.25-2.50	32.0-320.0	0.53-5.33	22.7-227.0	0.95-9.46	946.4-9464.0	15.8-158.0
S3V05	5	10:1	8.5-85.0	0.35-3.54	45.3-453.0	0.76-7.56	32.2-322.0	1.34-13.41	1340.7-13407.0	22.3-223.0
Approximate Outputs @ 50/60Hz										

### 100 psi (6.9 bar) max.

Item No. Prefix	Pump Tube	Turndown Ratio	Gallons per Day	Gallons per Hour	Ounces per Hour	Ounces per Min.	Liters per Day	Liters per Hour	Milliliters per Hour	Milliliters per Min.
S3V01	1	10:1	0.5-5.0	0.02-0.21	2.7-27.0	0.04-0.44	1.9-19.0	0.08-0.79	78.9-789.0	1.3-13.0
S3V02	2	10:1	1.7-17.0	0.07-0.71	9.1-91.0	0.15-1.51	6.4-64.0	0.27-2.68	268.1-2681.0	4.5-45.0
S3V07	7	10:1	4.0-40.0	0.17-1.67	21.3-213.0	0.36-3.56	15.1-151.0	0.63-6.31	630.9-6309.0	10.5-105.0
Approximate Outputs @ 50/60Hz										

## S4V Models

### 25 psi (1.7 bar) max.

Item No. Prefix	Pump Tube	Turndown Ratio	Gallons per Day	Gallons per Hour	Ounces per Hour	Ounces per Min.	Liters per Day	Liters per Hour	Milliliters per Hour	Milliliters per Min.
S4V5X	5X	10:1	15.0-150.0	0.63-6.25	80.0-800.0	1.33-13.33	56.7-567.0	2.37-23.66	2365.8-23658.0	39.4-394.0
Approximate Outputs @ 50/60Hz										

### 100 psi (6.9 bar) max.

Item No. Prefix	Pump Tube	Turndown Ratio	Gallons per Day	Gallons per Hour	Ounces per Hour	Ounces per Min.	Liters per Day	Liters per Hour	Milliliters per Hour	Milliliters per Min.
S4V7X	7X	10:1	6.0-60.0	0.25-2.50	32.0-320.0	0.53-5.33	22.7-227.0	0.95-9.46	946.4-9464.0	15.8-158.0
Approximate Outputs @ 50/60Hz										



**NOTICE:** The information within this chart is solely intended for use as a guide. The output data is an approximation based on pumping water under a controlled testing environment. Many variables can affect the output of the pump. Stenner Pump Company recommends that all metering pumps undergo field calibration by means of analytical testing to confirm their outputs.

# MATERIALS OF CONSTRUCTION

## All Housings

Polycarbonate

## Pump Tube

Santoprene® (FDA approved) or Versilon®

## Check Valve Duckbill (S3F & S3V Models)

Santoprene® (FDA approved) or Pellethane®

## Ball Check Valve Components (S4F & S4V Models)

- Ceramic ball (FDA approved); tantalum spring; FKM seat & O-ring **OR**
- Ceramic ball (FDA approved); stainless steel spring; EPDM seat; Santoprene® O-ring

## Pump Head Rollers

Polyethylene

## Roller Bushings

Oil impregnated bronze

## Suction/Discharge Tubing, Ferrules 1/4" & 6 mm

Polyethylene (FDA approved)

## Tube Fittings & Injection Fittings

PVC or Polypropylene (both NSF listed)

## Connecting Nuts

PVC or Polypropylene (both NSF listed)

## 3/8" Adapter (S3F & S3V Models)

PVC or Polypropylene (both NSF listed)

## Suction Line Strainer and Cap

PVC or Polypropylene (both NSF listed); ceramic weight

## All Fasteners

Stainless steel

## Pump Head Latches (S3F & S3V)

Polypropylene

## Pump Head Latches (S4F & S4V)

Stainless steel

## Leak Detect Components

Hastelloy®



# ACCESSORIES

## **S3F & S3V Models**

3 Connecting Nuts 1/4" or 3/8"

3 Ferrules 1/4" or 6 mm *EUROPE*

1 Injection Fitting 25 psi (1.7 bar) max. or 1 Duckbill Check Valve 100 psi (6.9 bar) max.

1 Weighted Suction Line Strainer 1/4", 3/8" or 6 mm *EUROPE*

1 20' Roll of Suction/Discharge Tubing 1/4" or 3/8", white, UV black or 6 mm white *EUROPE*

1 Additional Pump Tube

2 Additional Latches

1 Mounting Bracket

1 Manual

## **S4F & S4V Models**

3 Connecting Nuts 3/8"

1 Ball Check Valve

1 Weighted Suction Line Strainer 3/8"

1 20' Roll Suction/Discharge Tubing 3/8", white or UV black

1 Additional Pump Tube

1 Mounting Bracket

1 Manual

# OPERATION

## SELECT FIXED SERIES – S3F & S4F Models

The fixed speed models are not adjustable and run at 100% speed when power is applied to the pump.

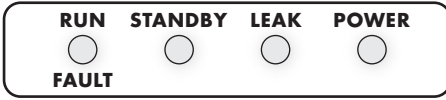

### LED Indicator Lights

#### RUN/FAULT

**RUN**      **Solid green** When the pump is running and not in drive fault.

**FAULT**    **Blinking red** if pump has a drive fault error.

To clear: Disconnect, then reconnect power, if FAULT is still present contact factory for evaluation.

**STANDBY** **Solid red** Pump received a contact closure on the standby inputs.

To clear: Automatically clears when pump no longer receives a contact closure on the standby inputs.

**LEAK**      **Blinking red** When a leak is detected.

To clear: Clears when the leak detect components are free of chemical or residue and power to the pump is disconnected, then reconnected.

**POWER**    **Solid green** Mains power is connected.

# OPERATION continued

## SELECT VARIABLE SERIES - S3V & S4V Models

- To turn the pump off, turn the potentiometer fully counterclockwise to .
- To gradually increase the speed to 100% turn the potentiometer clockwise. Graduations are approximate.

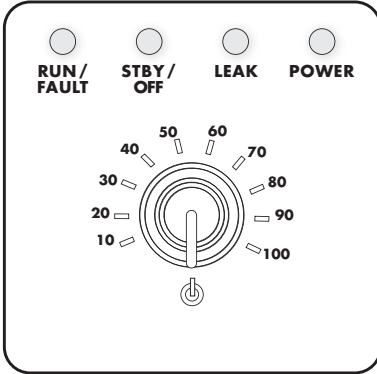

## LED Indicator Lights

### RUN/FAULT

**RUN**      **Solid green** When the pump is running and not in drive fault.

**FAULT**    **Blinking red** If pump has a drive fault error.

To Clear: Disconnect, then reconnect power, if FAULT is still present contact factory for evaluation.

### STANDBY/OFF

**STANDBY** **Solid red** Pump received a contact closure on the standby inputs.

To Clear: Automatically clears when pump no longer receives a contact closure on the standby inputs.

**OFF**      **Blinking red** When the potentiometer is set to .

**LEAK**    **Blinking red** When a leak is detected.

To Clear: Clears when the leak detect components are free of chemical or residue and power to the pump is disconnected, then reconnected.

**POWER**   **Solid green** Mains power is connected.

# CONNECTIONS

## USER INTERFACE CONNECTIONS

- The input and output connection terminals are located at the rear of the pump. To access it, unplug the pump and remove the signal cover by taking out the Phillips head screws that secure it in place.
- Prepare the signal cable by removing 3.5" of the outer jacket. Bare 0.25" on the ends of the signal wires. See cautionary note below on wire approval, shielding, size, etc.
- Loosen the outer nuts on the liquid tight cord grips. Remove rubber plug from the cord grip.
- Insert a sufficient length of signal cable through the cord grip to allow for wiring.
- Make connections as required.
- Adjust signal cable so that the outer jacket is flush with the inside of the cord grip. Tighten the cord grip nut flush with the cord grip body.
- Replace signal cover, ensuring that the signal wires do not get pinched between the signal cover and pump body.
- Replace the signal cover screws, using care to find existing threads, and tighten until the signal cover is evenly and fully tightened down flush.

**⚠ WARNING** Failure to properly tighten or secure the cord grip or signal cover may allow water to enter the pump enclosure, which can cause pump failure, property damage, or personal injury.

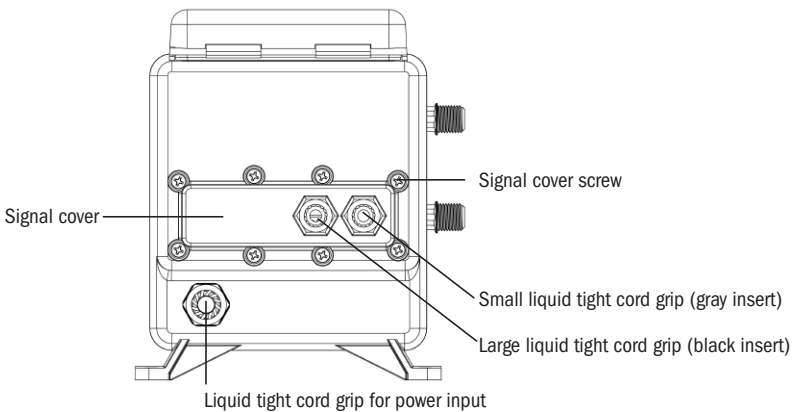

**⚠ CAUTION** Signal cables must be UL, cUL AWM Style 2464 approved with conductors between 28 AWG and 18 AWG. Jacket diameter for small liquid tight must be 0.064" to 0.210". Jacket diameter for large liquid tight must be 0.114" to 0.250".

# CONNECTIONS continued

## DIAGRAM

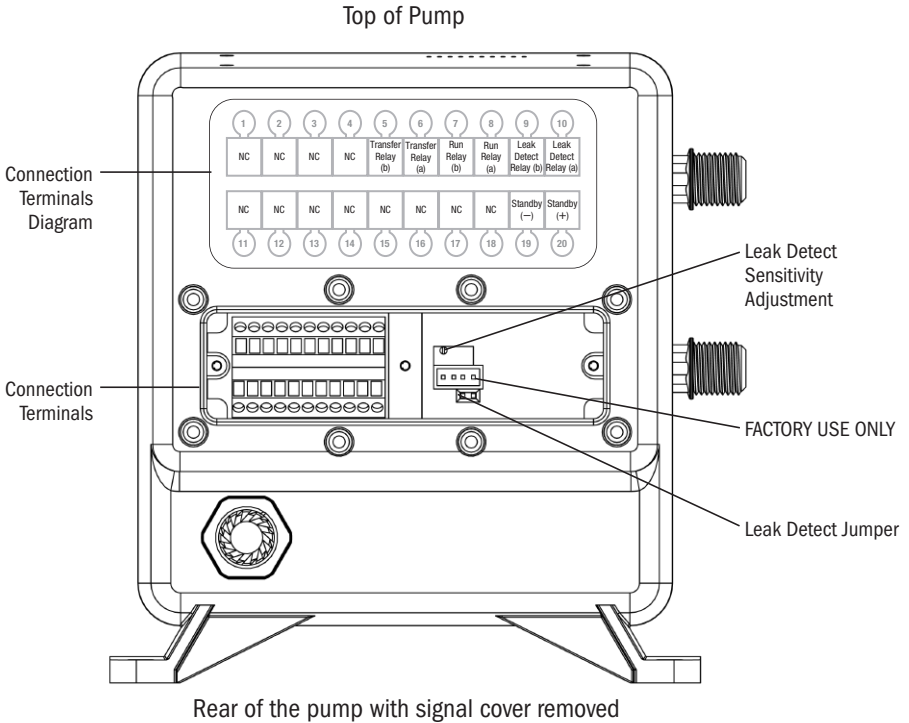

### LEAK DETECT JUMPER

- Pre-installed at the factory.
- When the jumper is installed & when a leak is detected, the pump stops running.
- When the jumper is not installed & when a leak is detected, the pump continues to run and the LED light & relay activation are not affected.

**⚠ CAUTION** If connecting a shielded signal cable to the pump, ensure that the shield wire is properly grounded on the controller (non-pump) side.

**⚠ CAUTION** DO NOT run signal wires in proximity to high voltage wires.

# CONNECTIONS continued

## OUTPUT RELAYS page 1 of 2

The relays are dry contacts, so there is no polarity to observe.

**⚠ WARNING** The output relays are for signal level only. Maximum rating is for 24VDC at 50mA.

### Leak Detect Relay

- Relay is normally open.
- If a leak is detected, this relay will close.
- The relay will remain closed until the leak condition is cleared and the power to the pump is cycled.
- Connect to Leak Detect Relay in positions 9 and 10.
- If the Leak Detect Jumper is removed, the relay activation is not affected.

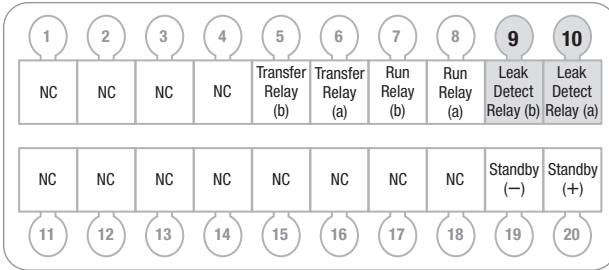

### Run Relay

- Relay is Normally Open.
- If the pump is running, this relay will close.
- Connect to Run Relay in positions 7 and 8.

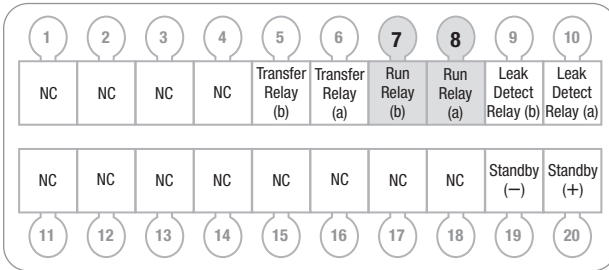

# CONNECTIONS continued

## OUTPUT RELAYS page 2 of 2

### Transfer Relay

- Relay is Normally Open, when power is applied to the pump, the relay closes.
- In the event of a drive fault, a leak, or a loss of power, this relay will open.

**⚠ CAUTION** DO NOT remove Leak Detect Jumper from primary pump. If jumper is removed, both pumps run at the same time.

Steps to set up a backup pump

- Primary pump's Transfer Relay in positions 5 & 6 must be wired to the backup pump's Standby input in positions 19 & 20.
- S3V or S4V Models, backup pump potentiometer setting must be the same setting as primary pump.

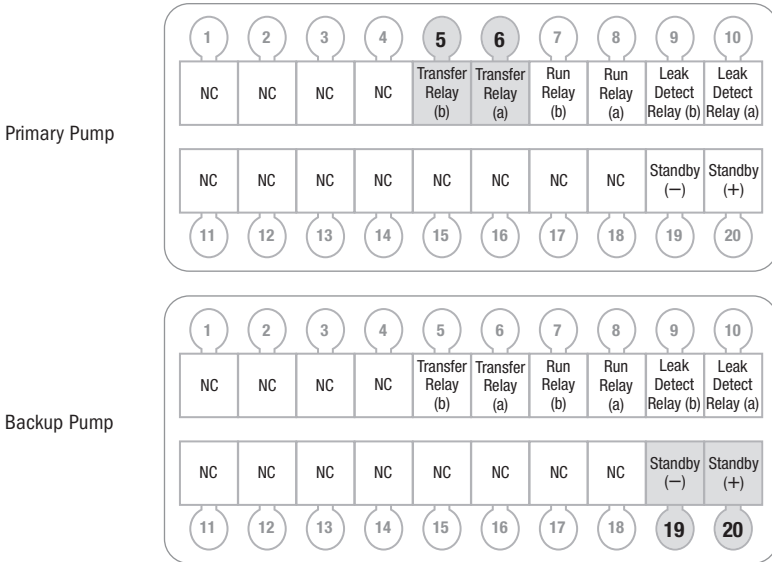

**NOTE:** If controlling the primary pump by mains power and if the primary & backup pumps are on separate circuits, then the backup pump will run when the primary pump is turned off by mains power.

# CONNECTIONS continued

## STANDBY

The Standby function can stop the pump remotely. When a dry contact or open collector signal is received to the Standby inputs, the pump ceases operation as long as the signal is present. In standby, the POWER/STANDBY LED is lit solid red.

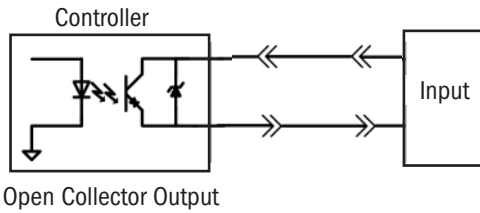
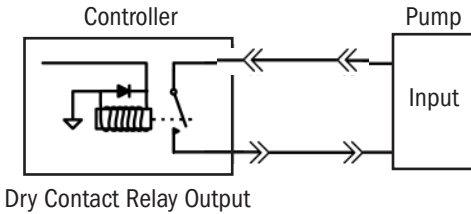

### For connection to a dry contact

- There is no polarity to observe.
- Connect relay to Standby (-), position 19 and Standby (+), position 20.

### For connection to an Open Collector output

- Polarity must be observed.
- Connect OC positive to Standby (+), position 20.
- Connect OC common to Standby (-), position 19.

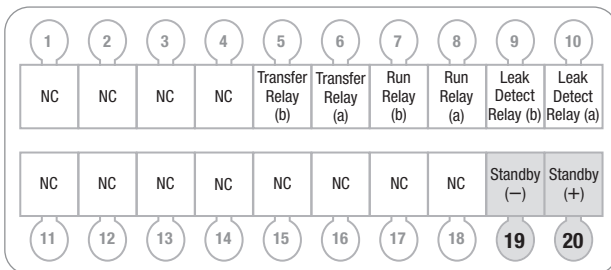



# SETTINGS

## LEAK DETECT page 1 of 3

The leak detect feature alerts if solution is present in the pump head by sensing the conductivity of the liquid. The sensitivity is factory preset to distinguish between water and common water treatment chemicals. Always calibrate the sensitivity with the chemical and chemical concentration utilized in the application to reduce the number of false tube leaks.

- When a leak is detected the Leak LED blinks red and the pump shuts off, unless the leak detect jumper was removed during installation.
- To reset the pump, the tube housing, cover and components must be clean & dry and the power must be disconnected and reconnected.
- The sensitivity is adjusted with the potentiometer (brass screw) located under the terminal cover on the back of the pump. Use a small flat blade screwdriver less than 3 mm to turn the potentiometer.

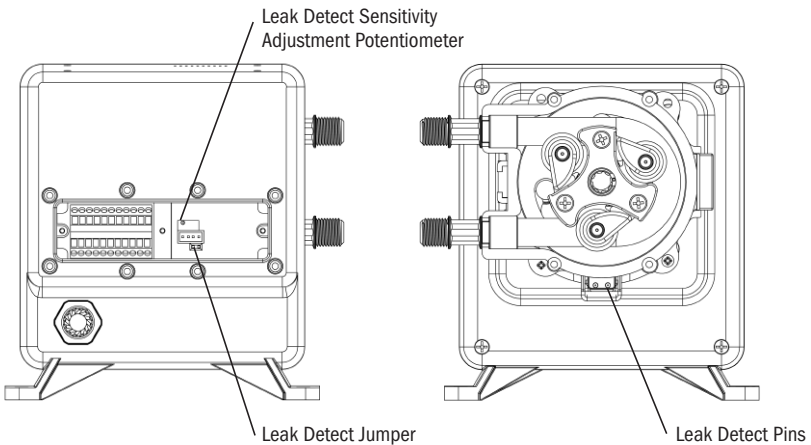

*Follow the leak detect sensitivity calibration steps on the next pages*

# SETTINGS continued

**LEAK DETECT** page 2 of 3

## CALIBRATE THE LEAK DETECT SENSITIVITY

**⚠ WARNING TO BE INSTALLED AND MAINTAINED BY PROPERLY TRAINED PROFESSIONAL INSTALLER ONLY. READ MANUAL & LABELS FOR ALL SAFETY INFORMATION & INSTRUCTIONS.**

**⚠ WARNING** Turn off water system, disable all pumps and depressurize the system before performing installation. Always wear proper protective safety equipment when working with metering pumps.

- 1. Fixed:** Put pump in Standby by connecting a jumper wire between terminals Standby (-) position 19 and Standby (+) position 20.

**Variable:** Turn pump off, by setting potentiometer to .

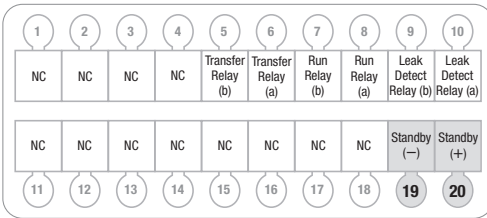

- 2.** Unplug the pump.
- 3.** Remove tube housing cover from the pump head.
- 4.** Remove the signal cover to allow access to the leak detect adjustment potentiometer.
- 5.** Use a small flat blade screwdriver less than 3 mm and turn the potentiometer clockwise until there is a clicking sound (approx. 25 rotations).
- 6.** Plug the pump in.

# SETTINGS continued

## LEAK DETECT page 3 of 3

7. Soak a small piece of sponge with the pumping solution and place over the two leak detect pins, use the expected weakest solution and keep in mind some solutions dilute with time.
8. Slowly turn the potentiometer counterclockwise until the LEAK LED blinks red.
9. Turn the potentiometer an additional one full turn counterclockwise.
10. Remove sponge and thoroughly clean the solution off pins and confirm they are dry.  
**IMPORTANT:** Confirm there is no chemical residue remaining on the leak detect pins and bracket.
11. Disconnect, then reconnect power. Confirm the LEAK LED is not lit. If lit, repeat steps 1-11. If the LEAK LED is not lit, go to step 12.
12. If the pump is not outdoors or exposed to water, go to step 14.
13. If the pump will be installed outdoors or exposed to water:
  - Soak a small piece of sponge in water and place over the two leak detect pins. If the tube LEAK LED is lit, it indicates the conductivity of the pumped solution and water is too close and the pump cannot discriminate between the two. The liquid end needs to be protected from water intrusion to avoid a false tube leak signal.
  - If the tube LEAK LED is not lit, the setting is complete.
14. Re-install the tube housing cover and the signal cover on the pump.  
On Fixed models, remove the jumper wire connected in step 1.
15. Prime the pump.
16. Verify pump operation.

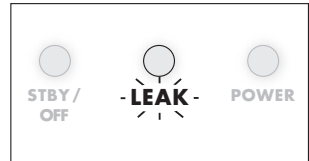

# INSTALLATION

## ADDITIONAL SAFETY INSTRUCTIONS



**NOTICE:** Indicates special instructions or general mandatory action.



Read all safety hazards before installing or servicing the pump. The pump is designed for installation and service by properly trained personnel.



Use all required personal protective equipment when working on or near a chemical metering pump.



Install the pump so that it is in compliance with all national and local plumbing and electrical codes.



Use the proper product to treat potable water systems, use only chemicals listed or approved for use.



Inspect tube frequently for leakage, deterioration, or wear. Schedule a regular pump tube maintenance change to prevent chemical damage to pump and/or spillage.



Recommended mounting is vertical with pump head pointed downward or horizontal sitting on motor base.

# INSTALLATION continued

## MOUNT PUMP

- ❗ **Recommended mounting is vertical with pump head pointed downward or horizontal sitting on motor base.**
  - ❗ **Select a dry location (to avoid water intrusion and pump damage) above the solution tank. Best recommended location is above the solution tank in a vertical position with the pump head pointed downward.**
  - ❗ **To prevent pump damage in the event of a pump tube leak, never mount the pump vertically with the pump head up.**
  - ❗ **To avoid chemical damage from fumes, DO NOT mount pump directly over an open solution tank. Keep tank covered.**
  - ❗ **Avoid flooded suction or pump mounted lower than the solution container. Draw solution from the top of the tank. Pump can run dry without damage. If pump is installed with a flooded suction, a shut-off valve or other device must be provided to stop flow to pump during service.**
1. Use the mounting bracket as a template to drill pilot holes in mounting location.
  2. Secure bracket with fasteners or wall anchors. Slide pump into bracket.
- ❗ **Provide 8" clearance to allow pump removal.**
  - ❗ **To prevent damage, verify with a volt meter that the receptacle voltage corresponds with the pump voltage.**
  - ❗ **On the S3V and the S4V models, after installation and after the settings are adjusted, be sure to tighten the screw on the cover of the control panel.**

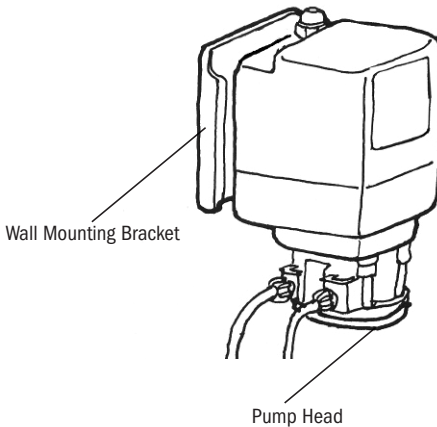

# INSTALLATION continued

## DIAGRAM

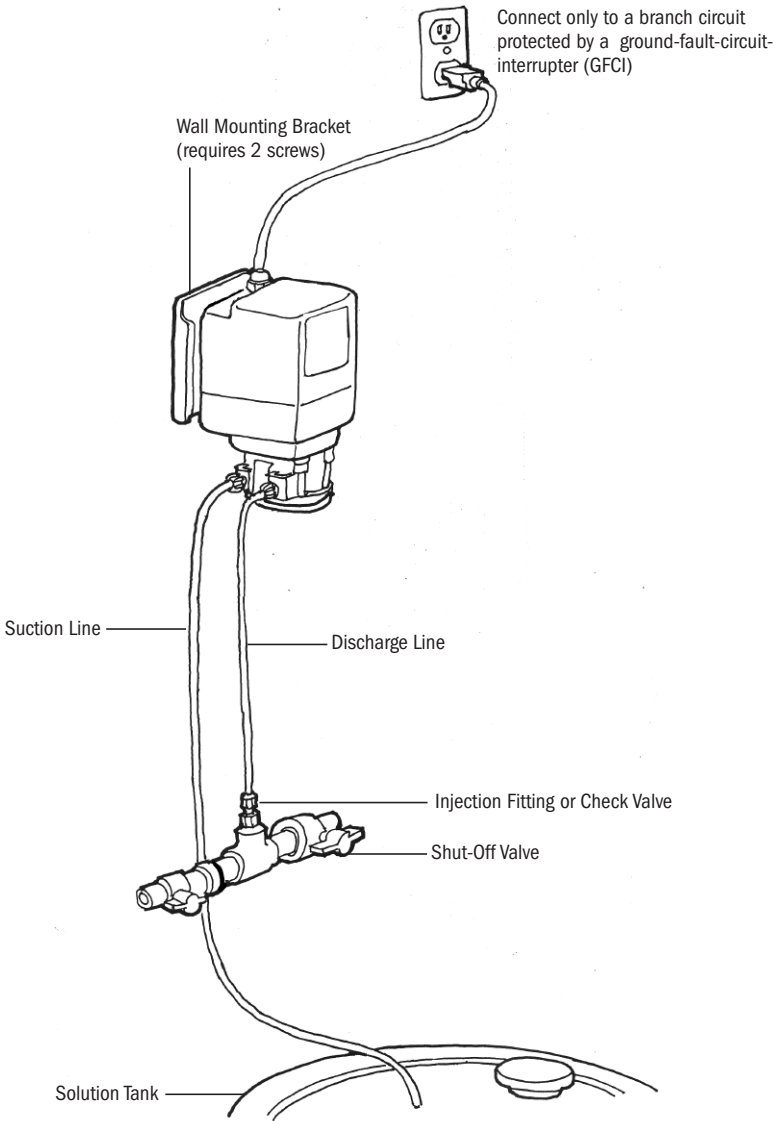

# INSTALLATION continued

## INSTALL SUCTION LINE TO PUMP HEAD

1. Uncoil the suction/discharge line. Use outside of solution tank as a guide to cut proper length of suction line ensuring it will be 2-3" above the bottom of solution tank.



**Allow sufficient slack to avoid kinks and stress cracks. Always make a clean square cut to assure that the suction line is burr free. Normal maintenance requires trimming.**



**Suction lines that extend to the bottom of the tank can result in debris pickup leading to clogged injectors and possible tube failure.**

2. Make connections by sliding the line(s) through connecting nut\* and ferrule and finger tighten to the corresponding tube fittings.

3. Finger tighten nut to the threaded tube fitting while holding the tube fitting.



**Overtightening the nut may result in damaged fittings or connections and air pickup.**



**DO NOT use thread seal tape on pump tube connections.**

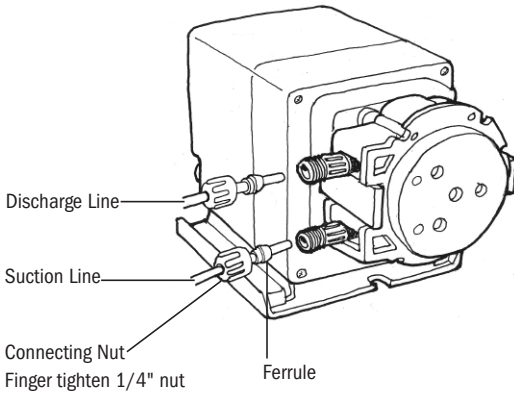

DO NOT use thread seal tape on pump tube threads.

Connecting Nut 3/8"

NOTE: Beveled ends of ferrules face pump. Tubing should bottom into all fittings.

### Nut Assembly Reference



PG Nut



Plastic Gripper



Sleeve

\* For 3/8" connections only. Slide line through 3/8" connecting nut and finger tighten to male end of adapter or pump tube fitting. While firmly holding the adapter or tube fitting, wrench tighten the 3/8" connecting nut one additional half turn. If leak occurs, gradually tighten the 3/8" connecting nut as required.

# INSTALLATION continued

## INSTALL SUCTION WEIGHT TO SUCTION LINE

1. Drill a hole into the bung cap or solution tank lid. Slide the tubing through and secure the weighted strainer to the line.
2. To attach the strainer, push approximately 3.5" of suction line through the cap on the strainer body. Pull tubing to make sure it is secure.
3. Suspend slightly above tank bottom to reduce the chance of sediment pickup.



**DO NOT mix chemicals in the solution container. Follow recommended mixing procedures according to the manufacturer.**



**DO NOT operate pump unless chemical is completely in solution. Turn pump off when replenishing solution.**

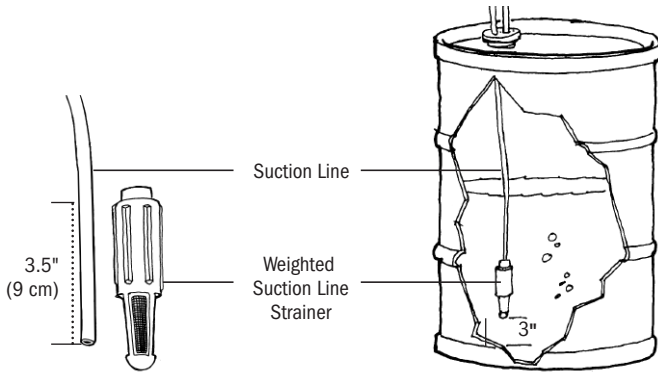



# INSTALLATION continued

## INSTALL DISCHARGE LINE TO PUMP HEAD AND INJECTION POINT

1. Make a secure finger tight connection on the discharge fitting of the pump head as instructed in Install Suction Line instructions.



**DO NOT use thread seal tape on pump tube connections or tools to tighten connections.**



**WARNING HAZARDOUS PRESSURE: Shut off water or circulation system and bleed off any system pressure.**



**Locate a point of injection beyond all pumps and filters or as determined by the application.**

2. A 1/4" or 1/2" Female NPT (FNPT) connection is required for installing the injection fitting. If there is no FNPT fitting available, provide one by either tapping the pipe or installing FNPT pipe tee fitting.
3. Wrap the Male NPT (MNPT) end of injection fitting with 2 or 3 turns of thread seal tape. If necessary, trim the injection fitting quill as required to inject product directly into flow of water.

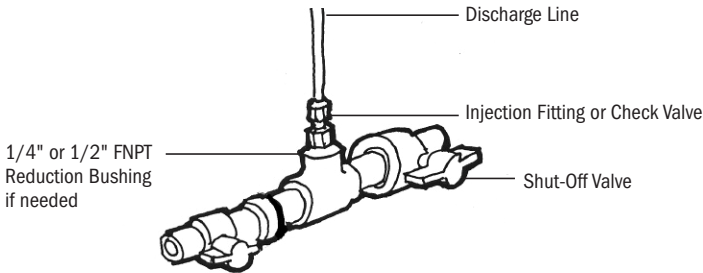

Typical Point of Injection



**DO NOT use thread seal tape on pump tube threads.**

# INSTALLATION continued

4. Hand tighten the injection fitting into the FNPT fitting.

## **Injection Fitting**

- a. Install connecting nut and ferrule to the pump discharge line. Insert discharge line into injection fitting until it reaches base of fitting.
- b. Finger tighten connecting nut to fitting. For 3/8" connections wrench tighten one additional 1/2 turn. If leak occurs, gradually tighten the 3/8" connecting nut as required.

## **Duckbill Check Valve or Ball Check Valve**

- a. Prior to connection, test check valve and NPT threads for leaks by pressurizing system. If necessary, tighten an additional 1/4 turn.
- b. Install connecting nut and ferrule to the pump discharge line. Insert discharge line into check valve body until it reaches base of body.
- c. Finger tighten connecting nut to fitting. For 3/8" connections wrench tighten one additional 1/2 turn. If leak occurs, gradually tighten the 3/8" connecting nut as required.

5. Prime the pump.

- **Fixed:** Connect the power.
- **Variable:** Set potentiometer to 100.

6. Re-pressurize system, observe chemical flow as actuated by system and check all connections for leaks.

7. After suitable amount of dosing time, perform tests for desired chemical readings. If necessary, fine tune dosing levels by adjusting solution strength.



**To allow quick access to the point of injection, installation of shut-off valves is recommended.**



**Regular cleaning of the check valve is needed to ensure proper functioning. Remove, inspect and clean components at every pump tube replacement. Replace components at least annually.**

# TROUBLESHOOTING – MOTOR



## **WARNING**

### **HAZARDOUS VOLTAGE:**

**DISCONNECT** power cord before removing motor cover for service. **Electrical service should be performed by trained personnel only.**

<b>PROBLEM</b>	<b>POSSIBLE CAUSE</b>	<b>SOLUTION</b>
Power LED is not on	No power cord connection point Failed power supply Pump requires re-initialization	Check voltage of receptacle/controller output voltage Return to factory for evaluation Disconnect, then reconnect power to the pump
No response to input signal	Fault, Standby or Leak has occurred	Refer to LED indicator pages for steps to clear condition
Output is higher or lower than expected	Incorrect tube size or setting	Install correct tube size according to instructions or adjust settings
Pump cycles ON/OFF	Failed fan High ambient temperature	Return to factory for evaluation The ambient temperature rating is 104°F (40°C)
Display is working, pump is not	Uncertain cause Failed motor Fault, Standby or Leak has occurred	Disconnect, then reconnect power to the pump Return to factory for evaluation Refer to LED indicator pages for steps to clear condition
Relay does not close or open for given condition	Relay output wired incorrectly	Output relays are dry contact and do not provide any voltage; confirm wiring is correct
Leak detect not working	Leak detect parts have chemical or residue on them or are not making contact or are missing Leak detect sensitivity was calibrated incorrectly	Install leak detect components; check to ensure pins are clean and making good contact Follow the leak detect sensitivity calibration instructions

# TROUBLESHOOTING – PUMP HEAD

PROBLEM	POSSIBLE CAUSE	SOLUTION
Components are cracking	Chemical attack	Check chemical compatibility
Pump head leaking	Pump tube rupture	Replace tube according to instructions
No pump output, pump head rotates	Depleted solution tank Pump suction line weight is above solution Leak in the suction line Ferrules installed incorrectly, missing or damaged Injection point is clogged Clogged suction and/or discharge line and/or check valve Life of roller assembly exhausted Life of pump tube exhausted Suction line is flush with the nose of the weighted strainer	Replenish solution Maintain suction line 2-3" above bottom of tank Inspect or replace suction line Replace ferrules Inspect and clean injection point Clean and/or replace as needed Replace roller assembly Replace tube according to instructions Pull suction line approximately 1" from bottom of strainer, cut bottom of suction line at an angle
Low pump output, pump head rotates	Life of roller assembly exhausted Life of pump tube exhausted Rollers worn or broken Injection point is restricted Incorrect tube size High system back pressure	Replace roller assembly Replace tube according to instructions Replace roller assembly Inspect and clean injection point Install correct tube size according to instructions Verify system pressure against tube psi, if needed replace tube according to instructions
No pump output, pump head doesn't rotate	Stripped roller assembly Motor problem	Replace roller assembly Refer to motor section
Pump output is high	Incorrect tube size or setting Roller assembly broken	Install correct tube size according to instructions or adjust settings Replace roller assembly



## S4F & S4V MODELS ONLY

**IMPORTANT: DO NOT TWIST THE TUBE** during installation. To ensure it doesn't twist, keep the tube positioned so the printed description stays aligned along the length of the tube.

# TROUBLESHOOTING – PUMP TUBE

**!** **NOTICE:** A leaking pump tube damages the metering pump. Inspect pump frequently for leakage and wear. Refer to Tube Replacement section for additional safety precautions and instructions.

PROBLEM	POSSIBLE CAUSE	SOLUTION
Tube leaking	<p>Pump tube ruptured</p> <p>Calcium or mineral deposits</p> <p>Excessive back pressure</p> <p>Tube is twisted</p> <p>Tube not centered</p> 	<p>Replace tube according to instructions</p> <p>Clean injection fitting &amp; replace tube according to instructions</p> <p>Verify system pressure against tube psi, if needed replace tube according to instructions</p> <p>Replace tube according to instructions</p> <p>Replace tube according to instructions</p> <p><b>IMPORTANT: DO NOT TWIST THE TUBE</b> during installation. To ensure it doesn't twist, keep the tube positioned so the <u>printed description</u> stays aligned along the length of the tube. Use your fingers to center the tube on the rollers.</p>
Tube life is shortened	<p>Chemical attack</p> <p>Mineral deposits at injection point</p> <p>Sediment blockage at check valve</p> <p>Degraded check valve duckbill</p> <p>Duckbill in wrong orientation</p> <p>Tube manually stretched or pinched during replacement</p> <p>Seized rollers caused abrasion on tube</p> <p>Exposure to heat or sun</p>	<p>Check chemical compatibility</p> <p>Clean injection point &amp; replace tube according to instructions</p> <p>Clean injection point according to instructions &amp; ensure suction line is 2-3" above tank bottom</p> <p>Replace duckbill at every tube change</p> <p>Reverse duckbill orientation</p> <p>Follow tube replacement instructions</p> <p>Clean roller assembly or replace</p> <p>Do not store tubes in high temperatures or in direct sunlight</p>
Tube connection is leaking	<p>Missing ferrule on 1/4" line</p> <p>Crushed 1/4" ferrule</p> <p>1/4" ferrule in wrong orientation</p> <p>Missing 3/8" nut sleeve or gripper</p> <p>Incorrect orientation of sleeve and/or plastic gripper inside 3/8" connection nut</p>	<p>Replace ferrule</p> <p>Replace ferrule</p> <p>Beveled ends of ferrules face pump. Tubing should bottom into all fittings</p> <p>Replace entire 3/8" connecting nut</p> <p>Beveled end of gripper should face nut; wider end of sleeve should face gripper</p>

# TUBE REPLACEMENT – SAFETY INFORMATION



## **WARNING** RISK OF CHEMICAL EXPOSURE



To reduce risk of exposure, check the pump tube regularly for leakage. At the first sign of leakage, replace the pump tube.



To reduce risk of exposure, the use of proper personal protective equipment is mandatory when working on or near chemical metering pumps.



To reduce risk of exposure, and also prior to service, shipping, or storage, pump generous amounts of water or a compatible buffer solution to remove chemical from pump.



Consult chemical manufacturer and SDS sheet for additional information and precautions for the chemical in use.



Personnel should be skilled and trained in the proper safety and handling of the chemicals in use.



Inspect tube frequently for leakage, deterioration, or wear. Schedule a regular pump tube maintenance change to prevent chemical damage to pump and/or spillage.



## **CAUTION** PINCH POINT HAZARD



Use extreme caution when replacing pump tube. Be careful of your fingers and **DO NOT** place fingers near rollers.



## **WARNING** HAZARDOUS PRESSURE/CHEMICAL EXPOSURE



Use caution and bleed off all resident system pressure prior to attempting service or installation.



Use caution when disconnecting discharge line from pump. Discharge may be under pressure. Discharge line may contain chemical.



## **NOTICE: Indicates special instructions or general mandatory action.**



**DO NOT** apply grease, oil, or lubricants to the pump tube or housing.



Prior to pump tube replacement, inspect the entire pump head for cracks or damaged components. Ensure rollers turn freely.



Rinse off chemical residual and clean all chemical and debris from pump head components prior to tube replacement. Apply AquaShield™ to main shaft and tube housing cover bushing during tube replacement.



**DO NOT** pull excessively on pump tube. Avoid kinks or damage during tube installation.



Inspect the suction and discharge lines, injection point (into pipe), and injection check valve duckbill for blockages after any tube rupture. Clear or replace as required.

# TUBE REPLACEMENT continued

## PREPARATION

1. Follow all safety precautions prior to tube replacement.
2. Prior to service, pump water or a compatible buffer solution through the pump and suction and discharge lines to remove chemical and avoid contact.

## REMOVE THE PUMP TUBE

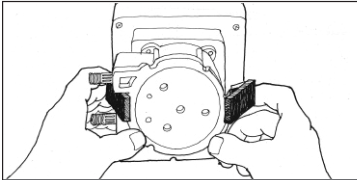

**A** Open latches

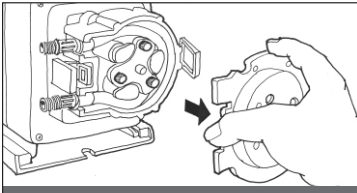

**B** Remove cover

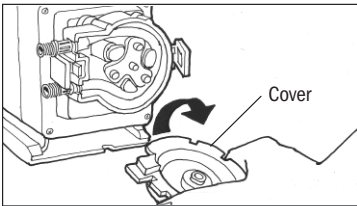

**C** Invert cover

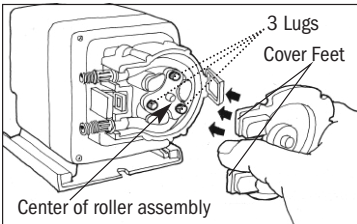

**D** Align cover feet near tube fitting

1. Unplug the power cord to ensure the power to the pump is off. Disconnect the input signal.
2. Depressurize and disconnect the suction and discharge lines.
3. Open the latches on both sides of the head. *Illustration A*

*For CE pump only:* Remove the safety screw on cover.

4. Remove the tube housing cover and flip to use as a tool in the next step. *Illustration B & C*
5. Align the center of the inverted cover with the center of the roller assembly so that the three holes on the face of the cover align with the three knurled lugs on the roller assembly. Position the cover feet near the tube fittings. *Illustration D*

NOTE: The roller assembly must be collapsed to remove the tube.

# TUBE REPLACEMENT continued

## REMOVE THE PUMP TUBE continued

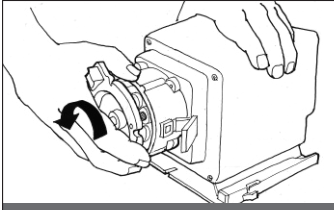

**E** Collapse roller assembly

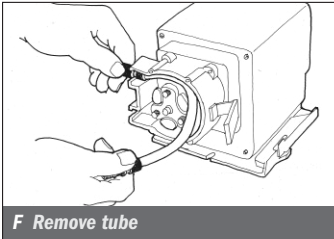

**F** Remove tube

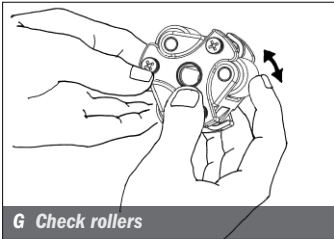

**G** Check rollers

6. Collapse the roller assembly.

### **S3F & S3V Models**

Hold the pump securely, use the tube housing cover as a wrench and quickly (snap) rotate the cover counterclockwise to collapse the roller assembly. The tube will no longer be pressed against the tube housing wall. *Illustration E*  
Go to #7.

### **S4F & S4V Models**



Hold the motor securely with one hand. With the other hand, hold the tube housing cover with your forefingers inside the top lip of the cover. Use the cover as a wrench and with your palm quickly (snap) rotate the cover counterclockwise to collapse the roller assembly. The tube will no longer be pressed against the tube housing wall.  
Go to #7.

7. Remove and discard the pump tube. *Illustration F*
8. Remove the roller assembly and housing. Set them aside to re-install later.
9. Use a non-citrus all-purpose cleaner to clean chemical residue from all pump components.
10. Check the housing for cracks. Replace if cracked.
11. Ensure the rollers turn freely. Replace the roller assembly if the rollers are seized or worn or if there is a reduction or lack of output from the pump. *Illustration G*
12. Reinstall clean tube housing.
13. Apply AquaShield™ to the shaft tip.
14. Install the roller assembly.



# TUBE REPLACEMENT continued

## INSTALL THE TUBE/EXPAND THE ROLLER ASSEMBLY

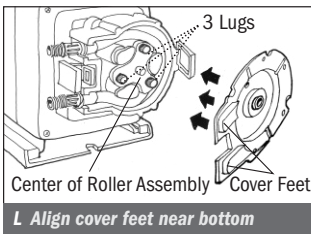
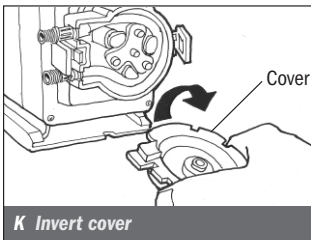
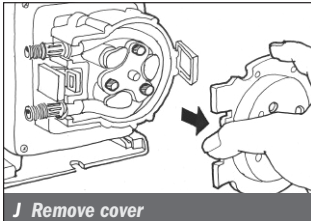
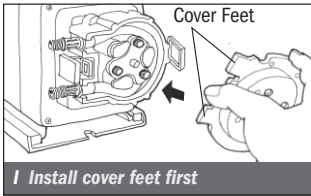
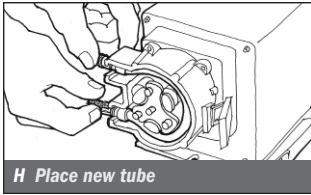

1. Ensure the power to the pump is off and the input signal is disconnected.
2. Install the tube. *Illustration H*

### S3F & S3V Models

Place the new tube in the pump head and use your fingers to center it on the rollers. *Go to #3.*

### S4F & S4V Models

- Place the new tube in the pump head.



**IMPORTANT: DO NOT TWIST THE TUBE** during installation. To ensure it doesn't twist, keep the tube positioned so the printed description stays aligned along the length of the tube.

- Use your fingers to center the tube on the rollers. *Go to #3.*

3. Place the tube housing cover (feet first) on the tube housing, affix the front of the latches to the cover lip and then press the latches back to secure. Be sure the cover is seated with the sleeve bearing on the shaft and is flush with the housing before latching. *Illustration I*
4. **Fixed:** Plug pump in.  
**Variable:** Set potentiometer to 100%.  
With cover latched, run the roller assembly in the collapsed position for four minutes.
5. Unplug the power cord.
6. Remove the tube housing cover and flip to use as a tool in the next step. *Illustration J and K*
7. Align the center of the inverted cover with the center of the roller assembly so that the three holes on the face of the cover align with the three knurled lugs on the roller assembly. Position the cover feet near the bottom. *Illustration L*

# TUBE REPLACEMENT continued

## INSTALL THE TUBE/EXPAND THE ROLLER ASSEMBLY continued

**IMPORTANT: THE ROLLER ASSEMBLY MUST BE EXPANDED** so the tube is pressed against the tube housing wall.

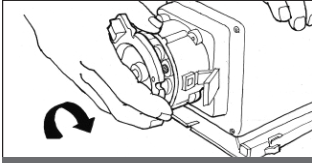

**M** Expand roller assembly

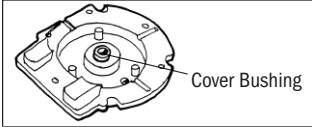

**N** Apply Aquashield™ to cover bushing

8. Hold the pump securely. Use the cover as a wrench and quickly (snap) rotate the roller assembly clockwise to expand the roller assembly. The tube will be pressed against the tube housing wall.

*Illustration M*

9. Apply a small amount of AquaShield™ to the cover bushing ONLY. DO NOT lubricate the pump tube.

*Illustration N*

10. Place the tube housing cover (feet first) on the tube housing, affix the front of the latches to the cover lip and then press the latches back to secure. Be sure the cover is seated with the sleeve bearing on the shaft and is flush with the housing before latching. **S4F & S4V go to #11.**

### S3F & S3V Models – Center the Tube

- Lift the latch located between the tube fittings, leaving the end of the latch engaged with the lip on the tube housing cover. Leave the latch on the opposite side engaged.
- **S3F:** Plug pump in.  
**S3V:** Set potentiometer to 100%.  
Turn tube fitting on the suction side not more than 1/8 of a turn in the direction the tube must move.
- Do not let go of the fitting until the tube rides approximately in the center of the rollers.
- **S3F:** Unplug pump.  
**S3V:** Turn potentiometer counterclockwise to .  
Let go of fitting & secure latch between the fittings. Go to #11.

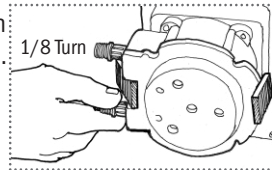
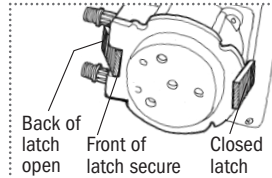



11. Inspect the suction and discharge lines, point of injection, and check valve for blockages. Clean and/or replace as required.
12. Reconnect the suction and discharge lines.
13. Prime pump and verify operation.

# CLEANING THE POINT OF INJECTION – SAFETY INFORMATION

 **NOTICE:** Indicates special instructions or general mandatory action.

 **NOTICE:** Pumps are supplied with an injection fitting or check valve. All allow the extension tip to be installed in the center of the pipe directly in the flow of water to help reduce deposit accumulation.

 **WARNING** Warns about hazards that **CAN** cause death, serious personal injury, or property damage if ignored.

 **This is the safety alert symbol. When displayed in this manual or on the equipment, look for one of the following signal words alerting you to the potential for personal injury or property damage.**

 **WARNING** HAZARDOUS PRESSURE/CHEMICAL EXPOSURE

 Use caution and bleed off all resident system pressure prior to attempting service or installation.

 Use caution when disconnecting discharge line from pump. Discharge line may be under pressure. Discharge line may contain chemical.

 To reduce risk of exposure, the use of proper personal protective equipment is mandatory when working on or near chemical metering pumps.

# CLEANING THE POINT OF INJECTION continued

1. Disconnect power. Disable any water pump or auxiliary equipment's electrical supply.
2. Depressurize system and bleed pressure from pump discharge line.
3. Loosen and remove the 3/8" or 1/4" nut & ferrule from the check valve or injection fitting to disconnect discharge line.

## Duckbill Check Valve

- Unscrew the check valve body (top fitting) and remove the duckbill
- Inspect and replace duckbill as needed

## Ball Check Valve

- Unscrew the check valve body (top fitting) and remove the ball check components. Be careful not to stretch or damage the spring.
- Inspect and replace parts as needed.

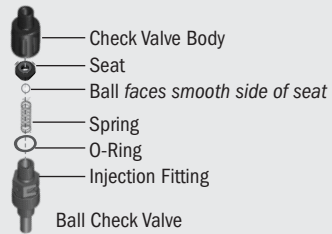

4. Insert a #2 Phillips head screwdriver through injection fitting into the pipe to locate or break up accumulated deposits. If screwdriver cannot be inserted, drill the deposit out of the injection fitting. DO NOT drill through the opposite pipe wall.

# CLEANING THE POINT OF INJECTION continued

5. Replace discharge line if cracked or deteriorated. If the end is clogged, cut off the calcified or blocked section of discharge line.

## Injection Fitting

Replace ferrule and reinstall the discharge line to the injection fitting approximately 3/4"-1" until it stops.

## Duckbill Check Valve

- Reassemble the check valve.
- Replace ferrule and reinstall the discharge line to the injection check valve approximately 3/4" until it stops.

## Ball Check Valve

- Reassemble the check valve, refer to illustration. The smooth side of the seat must face the ball.
- Reinstall the discharge line to the injection check valve approximately 3/4" until it stops.

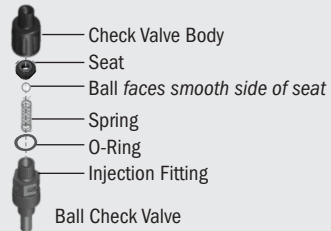

6. Tighten the connecting nut finger tight while firmly holding the tube fitting. The 3/8" nut may be wrench tightened one additional half turn. If leak occurs, gradually tighten the 3/8" nut as required.
7. Enable the water pump electrical supply and pressurize the water system.  
NOTE: The roller assembly must be expanded so the tube is pressed against the tube housing wall.
8. Put the metering pump back in service and inspect all connections for leaks.

# PUMP HEAD PARTS

## S3F & S3V Models

PART NUMBER	UM	DESCRIPTION
S3400-1	EA	S3QP Tube Housing with Latches
S3400-2	2-PK	
S3500-1	EA	S3QP Roller Assembly
S3500-4	4-PK	
S3600-1	EA	S3QP Tube Housing Cover
S3600-4	4-PK	
QP401-2	2-PK	Plastic Latches

## S4F & S4V Models

PART NUMBER	UM	DESCRIPTION
S4400-1	EA	S4QP Tube Housing with Latches
S4400-2	2-PK	
S4500-1	EA	S4QP Roller Assembly
S4500-4	4-PK	
S4600-1	EA	S4QP Tube Housing Cover
S4600-4	4-PK	

# PUMP HEADS

Refer to the **FLOW RATE OUTPUTS** chart to match the pump with the correct tube.

## S3F & S3V Models

**25 psi (1.7 bar) max.** Includes S3QP pump head, tube, ferrules 1/4" (EUROPE 6 mm)

PART NUMBER	UM	DESCRIPTION
S310 ■-1	EA	S3QP Pump Head; Santoprene® tube
S310 ■-2	2-PK	select # 3, 4 or 5 for ■
S320 ■-1	EA	S3QP Pump Head; Versilon® tube select # 3, 4 or 5 for ■
<b>EUROPE</b>		
S315 ■-1	EA	S3QP Pump Head; Santoprene® tube
S315 ■-2	2-PK	select # 3, 4 or 5 for ■
S325 ■-1	EA	S3QP Pump Head; Versilon® tube select # 3, 4 or 5 for ■

**100 psi (6.9 bar) max.** Includes S3QP pump head, tube, duckbill, ferrules 1/4" (EUROPE 6 mm)

PART NUMBER	UM	DESCRIPTION
S310 ■-1	EA	S3QP Pump Head; Santoprene® tube
S310 ■-2	2-PK	select # 1, 2 or 7 for ■
S320 ■-1	EA	S3QP Pump Head; Versilon® tube select # 1 or 2 for ■
<b>EUROPE</b>		
S315 ■-1	EA	S3QP Pump Head; Santoprene® tube
S315 ■-2	2-PK	select # 1, 2 or 7 for ■
S325 ■-1	EA	S3QP Pump Head; Versilon® tube select # 1 or 2 for ■

## S4F & S4V Models

**25 psi (1.7 bar) max.** Includes S4QP pump head and tube

PART NUMBER	UM	DESCRIPTION
S4105X-1	EA	S4QP Pump Head; #5X Santoprene® tube
S4105X-2	2-PK	

**100 psi (6.9 bar) max.** Includes S4QP pump head and tube

PART NUMBER	UM	DESCRIPTION
S4107X-1	EA	S4QP Pump Head; #7X Santoprene® tube
S4107X-2	2-PK	

NOTE: Confirm material compatibility with the chemical resistance guide.

# PUMP HEAD SERVICE KITS

Refer to the **FLOW RATE OUTPUTS** chart to match the pump with the correct tube.

## S3F & S3V Models

**25 psi (1.7 bar) max.** Inc. S3QP roller assembly, tube, latches, 1/4" nuts & ferrules (*EUROPE 6 mm*)

PART NUMBER	UM	DESCRIPTION
S310 ■ K	KIT	S3QP Pump Head Service Kit; Santoprene® tube select # 3, 4 or 5 for ■
S320 ■ K	KIT	S3QP Pump Head Service Kit; Versilon® tube select # 3, 4 or 5 for ■

### EUROPE

S311 ■ K	KIT	S3QP Pump Head Service Kit; Santoprene® tube select # 3, 4 or 5 for ■
S321 ■ K	KIT	S3QP Pump Head Service Kit; Versilon® tube select # 3, 4 or 5 for ■

**100 psi (6.9 bar) max.** Inc. S3QP roller assembly, tube, latches, duckbill, 1/4" nuts & ferrules (*EUROPE 6 mm*)

PART NUMBER	UM	DESCRIPTION
S310 ■ K	KIT	S3QP Pump Head Service Kit; Santoprene® tube select # 1, 2 or 7 for ■
S320 ■ K	KIT	S3QP Pump Head Service Kit; Versilon® tube select # 1 or 2 for ■

### EUROPE

S311 ■ K	KIT	S3QP Pump Head Service Kit; Santoprene® tube select # 1, 2 or 7 for ■
S321 ■ K	KIT	S3QP Pump Head Service Kit; Versilon® tube select # 1 or 2 for ■

## S4F & S4V Models

**25 psi (1.7 bar) max.** Includes S4QP roller assembly, tube, 3/8" nuts

PART NUMBER	UM	DESCRIPTION
S4105XK	KIT	S4QP Pump Head Service Kit; #5X Santoprene® tube

**100 psi (6.9 bar) max.** Includes S4QP roller assembly, tube, 3/8" nuts

PART NUMBER	UM	DESCRIPTION
S4107XK	KIT	S4QP Pump Head Service Kit; #7X Santoprene® tube

NOTE: Confirm material compatibility with the chemical resistance guide.



# PUMP TUBES

Refer to the **FLOW RATE OUTPUTS** chart to match the pump with the correct tube.

## S3F & S3V Models

Includes ferrules 1/4" (EUROPE 6 mm)

PART NUMBER	UM	DESCRIPTION
UCCP20 ■	2-PK	Santoprene® tube select # 1, 2, 3, 4 or 5 for ■
MCCP20 ■	5-PK	
UCCP207	2-PK	Santoprene® #7 tube
MCCP207	5-PK	
UCTYGO ■	2-PK	Versilon® tube select # 1, 2, 3, 4 or 5 for ■
MCTYGO ■	5-PK	

### EUROPE

UCCP2 ■ CE	2-PK	Santoprene® tube select # 1, 2, 3, 4 or 5 for ■
MCCP2 ■ CE	5-PK	
UCCP27CE	2-PK	Santoprene® #7 tube
MCCP27CE	5-PK	
UCTY ■ CE	2-PK	Versilon® tube select # 1, 2, 3, 4 or 5 for ■
MCTY ■ CE	5-PK	

Includes duckbill, ferrules 1/4" (EUROPE 6 mm)

UCCP ■ FD	2-PK	Santoprene® tube select # 1 or 2 for ■
UCCP7FD	2-PK	Santoprene® #7 tube
UCTY ■ FD	2-PK	Versilon® tube select # 1 or 2 for ■

### EUROPE

UC ■ FDCE	2-PK	Santoprene® tube select # 1 or 2 for ■
UC7FDCE	2-PK	Santoprene® #7 tube
UCTY ■ DCE	2-PK	Versilon® tube select # 1 or 2 for ■

## S4F & S4V Models

PART NUMBER	UM	DESCRIPTION
S4005X-2	2-PK	Santoprene® #5X tube
S4005X-5	5-PK	
S4007X-2	2-PK	Santoprene® #7X tube
S4007X-5	5-PK	

NOTE: Confirm material compatibility with the chemical resistance guide.

# CHECK VALVES

## S3F & S3V Models

### Duckbill Check Valves 100 psi (6.9 bar) max.

PART NUMBER	UM	DESCRIPTION
UCDBINJ	EA	1/4" includes Santoprene® duckbill, nut, ferrule
MCDBINJ	5-PK	
UCTYINJ	EA	1/4" includes Pellethane® duckbill, nut, ferrule
MCTYINJ	5-PK	
UCINJ38	EA	3/8" includes Santoprene® duckbill, nut
MCINJ38	5-PK	
UCTYIJ38	EA	3/8" includes Pellethane® duckbill, nut
MCTYIJ38	5-PK	

### EUROPE

UCINJCE	EA	6 mm includes Santoprene® duckbill, nut, ferrule
MCINJCE	5-PK	
UCTINJCE	EA	6 mm includes Pellethane® duckbill, nut, ferrule
MCTINJCE	5-PK	

## S4F & S4V Models

### Ball Check Valve

PART NUMBER	UM	DESCRIPTION
BC038-1	EA	3/8" includes FKM seat & O-ring, tantalum spring, nut
BC238-1	EA	3/8" includes EPDM seat, Santoprene® O-ring, stainless steel spring, nut

NOTE: Confirm material compatibility with the chemical resistance guide.

# CHEMICAL RESISTANCE GUIDE

## Ratings Key – Chemical Effect

**A** Fluid has minor or no effects

**B** Fluid has minor to moderate effects

**C** Fluid has severe effects

• No data available

 **CAUTION** The information is provided ONLY as a guide to assist in determining chemical compatibility for wetted components. Testing under the specific conditions of the application is recommended. Stenner Pump Company assumes no responsibility for its accuracy. Outside factors including but not limited to temperature, pressure, mechanical stress, and solution concentration can affect material compatibility in a particular application. Stenner makes no warranty, expressed or implied, as to the accuracy of this guide or any materials' suitability for fitness or purpose for any application. User assumes all risk and liability for use of this guide.

Chemical / Solution	PP Santoprene® EPDM	Versilon®	PVC	LDPE	FKM	Silicone	Tantalum	Stainless Steel
Acetic Acid 20%	A	B	B	A	B	A	A	A
Acetic Acid 30%	B	C	C	A	B	A	A	B
Acetic Acid, Glacial	C	C	C	C	C	•	A	A
Acetic Anhydride	B	C	C	C	C	C	•	A
Aliphatic Hydrocarbons	B	B	B	B	•	•	•	•
Aluminum Chloride	A	A	A	B	A	B	A	B
Aluminum Sulfate	A	A	A	A	A	A	A	B
Alums	A	A	A	A	A	A	•	A
Ammonium Acetate	B	B	A	A	A	•	•	A
Ammonium Carbonate	A	A	A	A	A	C	•	B
Ammonium Chloride	A	B	A	B	A	C	A	B
Ammonium Hydroxide	A	B	A	A	B	A	B	A
Ammonium Nitrate	A	A	A	A	B	C	A	A
Ammonium Phosphate	A	A	A	A	A	A	•	C
Ammonium Sulfate	A	A	A	A	B	A	A	B
Amyl Acetate	A	C	C	C	C	C	•	A
Aniline	B	C	C	C	C	C	A	B
Antimony Salts	A	A	A	B	•	•	•	•
Arsenic Salts	A	A	A	B	•	•	•	•
Barium Hydroxide	A	A	A	B	A	•	B	B
Barium Salts	A	•	A	B	•	A	•	•
Beer	A	A	A	A	A	•	A	A
Benzene	C	C	C	C	B	•	•	B
Benzoic Acid	A	C	A	A	A	•	A	B
Bleach 5.25%	A	A	A	A	A	•	•	•
Boric Acid	A	A	A	A	A	A	A	A
Bromine	A	B	B	B	A	C	A	C
Butyl Acetate	A	C	C	C	C	C	•	A
Butyric Acid	A	C	B	C	B	C	A	B
Calcium Chloride	A	A	B	A	A	•	A	B
Calcium Hydroxide	A	C	A	A	A	•	B	B

# CHEMICAL RESISTANCE GUIDE continued

Chemical / Solution	PP Santoprene® EPDM	Versilon®	PVC	LDPE	FKM	Silicone	Tantalum	Stainless Steel
Calcium Hypochlorite 5%	A	B	A	A	A	•	A	B
Calcium Salts	A	A	A	A	•	B	•	•
Carbon Disulfide	C	C	C	C	A	•	•	B
Carbon Tetrachloride	C	C	C	C	A	C	•	B
Castor Oil	B	A	A	•	A	•	•	A
Chlorine <i>see Sodium Hypochlorite</i>								
Chloroacetic Acid	A	C	B	C	C	•	•	A
Chloroform	C	C	C	C	A	C	•	A
Chlorosulfonic Acid	B	C	C	C	C	C	•	B
Chromic Acid < 50%	B	C	B	A	A	C	A	B
Chromium Salts	A	•	A	B	•	•	•	•
Citric Acid	B	B	B	C	A	•	A	A
Copper Chloride	A	A	A	A	A	•	A	C
Copper Sulfate	A	A	A	A	A	•	A	B
Cottonseed Oil	B	A	B	A	A	•	•	A
d-Limonene	C	B	B	B	A	C	•	•
Ethyl Acetate	A	C	C	C	C	B	•	B
Ethyl Alcohol	B	C	C	B	B	•	A	•
Ethyl Chloride	C	C	C	C	A	C	•	A
Ethylene Dichloride	C	C	C	C	A	C	•	B
Ethylene Glycol	A	A	A	A	A	A	•	B
Ethylene Oxide	B	A	C	C	C	C	•	B
Eucalyptus Oil	C	B	C	C	•	•	•	•
Fatty Acids	C	B	A	A	A	C	•	A
Ferric Chloride	A	A	A	A	A	B	A	C
Ferric Sulfate	A	A	A	A	A	B	•	B
Ferrous Chloride	A	A	A	A	A	C	•	C
Ferrous Sulfate	A	A	A	A	A	C	•	B
Fluoboric Acid	A	C	A	C	B	A	•	•
Fluosilicic Acid	A	A	A	A	A	C	•	B
Formaldehyde < 40%	A	B	A	C	C	B	•	A
Formic Acid	A	C	B	C	C	C	A	A
Glucose	A	A	A	A	A	A	•	A
Glycerin	A	A	A	A	A	A	•	A
Hydrochloric Acid 20%	A	C	A	A	A	C	A	C
Hydrochloric Acid 37%	A	C	A	A	A	C	A	C
Hydrocyanic Acid	A	B	A	A	A	C	A	A
Hydrofluoric Acid < 48%	A	C	B	A	A	C	C	C
Hydrofluoric Acid 48-75%	A	C	C	C	A	C	C	C
Hydrofluoric Acid, anhydrous	B	C	C	C	C	•	C	C
Hydrogen Peroxide < 50%	A	B	A	B	A	A	A	A
Hydrogen Sulfide	A	A	B	A	C	•	•	A

# CHEMICAL RESISTANCE GUIDE continued

Chemical / Solution	PP Santoprene® EPDM	Versilon®	PVC	LDPE	FKM	Silicone	Tantalum	Stainless Steel
Iodine	A	A	C	B	A	C	A	C
Lactic Acid	A	B	B	A	A	A	A	B
Lead Acetate	B	A	A	A	C	C	•	B
Linseed Oil	B	A	A	A	A	A	•	A
Limonene	C	B	B	B	A	C	•	•
Lubricating Oils	C	A	B	C	A	•	•	A
Magnesium Chloride	A	A	B	A	A	A	A	C
Magnesium Hydroxide	A	A	A	A	A	•	A	A
Magnesium Sulfate	A	A	A	A	A	A	A	B
Malic Acid	A	B	A	A	A	B	•	A
Manganese Salts	A	A	A	A	•	B	•	•
Mercuric Chloride	A	A	A	A	A	•	•	C
Methylene Chloride	C	C	C	C	B	•	A	B
Mineral Oil	B	A	B	B	A	•	•	•
Mineral Spirits	C	A	B	B	A	•	•	A
Muriatic Acid, 20° Baume	A	C	A	A	A	•	•	•
Nitric Acid < 10%	A	C	A	B	A	B	A	A
Nitric Acid 10-30%	B	C	A	C	A	C	A	A
Nitric Acid 30-60%	C	C	B	C	A	C	A	A
Nitric Acid 70%	C	C	B	C	A	C	A	A
Nitric Acid, red fuming	C	C	C	C	C	C	•	•
Nitrous Acid	A	B	•	•	B	•	•	B
Oleic Acid	A	B	C	C	B	C	•	A
Oleum 20-25%	C	C	C	C	•	•	•	B
Oxalic Acid	A	C	B	A	A	C	A	A
Palmitic Acid	A	B	B	A	A	C	•	A
Petroleum Distillates	C	B	B	C	•	•	A	A
Peracetic Acid 5%	B	B	B	A	A	A	•	•
Peracetic Acid 15%	B	B	B	A	A	B	•	•
Phenol	B	C	C	B	A	C	•	B
Phosphoric Acid	A	C	A	A	A	C	A	C
Phthalic Acid	A	C	A	A	A	B	•	A
Pickling Solutions	A	C	•	•	B	•	•	•
Plating Solutions	A	C	•	•	A	C	•	•
Polyphosphate	A	A	A	A	•	•	•	•
Potassium Carbonate	A	A	A	A	A	•	•	B
Potassium Chlorate	A	A	A	A	A	B	•	B
Potassium Hydroxide	A	A	A	A	C	C	B	A
Potassium Dichromate	A	A	A	A	A	•	•	B
Potassium Iodide	A	A	B	B	A	•	•	A
Potassium Permanganate	A	A	A	A	A	•	•	B
Sea Water	A	A	A	A	A	•	A	C

# CHEMICAL RESISTANCE GUIDE continued

Chemical / Solution	PP Santoprene® EPDM	Versilon®	PVC	LDPE	FKM	Silicone	Tantalum	Stainless Steel
Silicone Oil	C	A	A	B	A	C	•	A
Silver Nitrate	A	A	A	A	A	A	•	B
Soap Solutions	A	A	A	C	A	A	•	A
Sodium	A	A	A	A	•	•	•	•
Sodium Bisulfate	A	A	A	A	A	•	•	C
Sodium Bisulfite	A	A	A	A	A	A	•	B
Sodium Borate	A	A	A	A	A	A	•	B
Sodium Carbonate	A	A	A	A	A	A	•	A
Sodium Chlorate	A	A	A	A	A	C	•	B
Sodium Chloride	A	A	A	A	A	A	A	B
Sodium Dichromate 20%	A	•	B	•	A	•	•	•
Sodium Hydroxide < 20%	A	B	A	B	C	A	B	B
Sodium Hydroxide 20-46.5%	A	C	A	B	C	•	C	B
Sodium Hypochlorite 5%	A*	B	A	A	A	B	A	C
Sodium Hypochlorite 6-15%	A*	B	A	A	A	B	A	C
Sodium Nitrate	A	A	A	A	A	C	A	B
Sodium Silicate	A	A	A	A	A	A	•	B
Sodium Sulfide	A	A	A	A	A	A	•	C
Sodium Sulfite	A	A	A	A	A	A	•	A
Solvents	C	B	B	B	•	•	•	•
Soybean Oil	B	A	A	A	A	•	•	A
Stannous Chloride 15%	A	A	A	B	A	•	•	A
Stearic Acid	A	B	B	B	A	B	•	A
Sulfur Dioxide liquid	A	C	C	C	B	•	•	A
Sulfur Trioxide	B	C	A	C	A	•	•	C
Sulfuric Acid < 40%	B	B	B	B	A	C	A	C
Sulfuric Acid > 40%	C	C	C	C	A	C	A	C
Sulfurous Acid	A	A	A	B	C	C	•	B
Tannic Acid 10%	A	B	A	B	A	B	•	A
Tanning Liquors	A	A	A	A	A	•	•	A
Tartaric Acid	A	A	A	A	A	A	•	C
Titanium Salts	A	A	A	B	•	•	•	•
Triethanolamine	A	C	C	C	C	•	•	•
Trisodium Phosphate	A	A	A	A	A	•	•	B
Tung Oil	B	B	C	C	A	•	•	•
Turpentine	B	B	C	C	A	C	•	A
Urea	B	A	B	A	A	B	•	B
Water & Brine	A	A	A	A	A	B	•	•
Zinc Chloride	A	A	B	A	A	A	A	B
Zinc Salts	A	A	A	A	•	•	•	•

NOTE: FKM tested to ANSI/NSF 61 with water only.

\* Products tested and certified by WQA according to ANSI/NSF 61 for contact with Sodium Hypochlorite and Water only and ANSI/NSF 372.

# WALL MOUNTING BRACKET DIMENSIONS

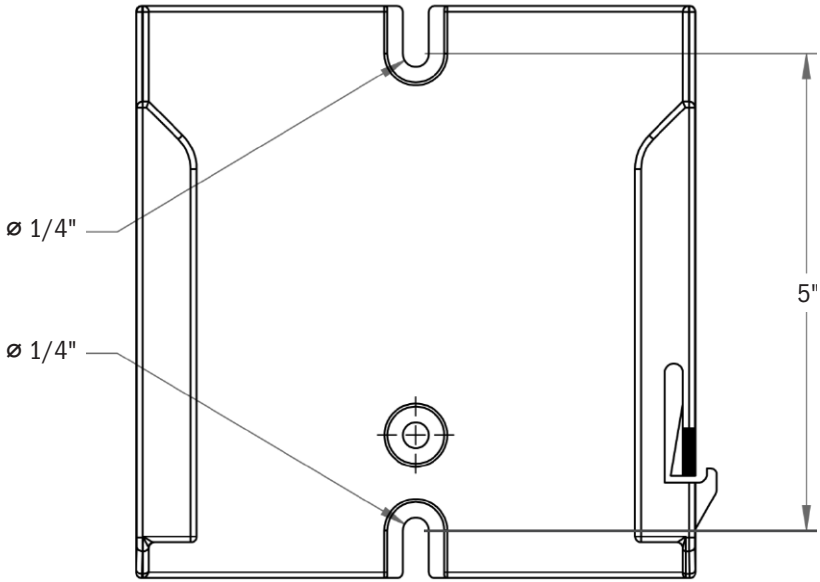

**NOTICE:** Leave 8" of clearance above pump to allow for removal from mounting bracket.

# STENNER PUMPS<sup>®</sup>

## STENNER PUMP COMPANY

3174 DeSalvo Road  
Jacksonville, Florida 32246 USA

Phone: 904.641.1666

US Toll Free: 800.683.2378

Fax: 904.642.1012

[sales@stenner.com](mailto:sales@stenner.com)

[www.stenner.com](http://www.stenner.com)

Hours of Operation (EST):

Mon.-Thu. 7:30 am-5:30 pm

Fri. 7:00 am-5:30 pm

 Assembled in the USA

© Stenner Pump Company  
All Rights Reserved