



PCM SERIES PUMP CONTROL MODULE
INSTALLATION AND MAINTENANCE MANUAL

PERISTALTIC METERING PUMPS SINCE 1957

TABLE OF CONTENTS

WARRANTY AND SERVICE POLICY	3
SAFETY INFORMATION	4-5
SPECIFICATIONS.....	6
SIZING	7-11
INSTALLATION.....	12-13
TROUBLESHOOTING	14
PCM OPERATING RANGE CONVERSION	15

IMPCM Rev0312

WARRANTY AND CUSTOMER SERVICE

LIMITED WARRANTY

Stenner Pump Company will for a period of one (1) year from the date of purchase (proof of purchase required) repair or replace – at our option – all defective parts. Stenner Pump Company is not responsible for any removal or installation costs. Stenner Pump Company will incur shipping costs for warranty products shipped from our factory in Jacksonville, Florida. Any tampering with major components, chemical damage, faulty wiring, weather conditions, power surges, or products not used with reasonable care and maintained in accordance with the instructions will void the warranty. Stenner Pump Company limits its liability solely to the cost of the original product. We make no other warranty expressed or implied.

RETURNS

Stenner offers a 30-day return policy. Except as otherwise provided, no material will be accepted for return after 30 days from purchase. To return merchandise at any time, call Stenner at 800-683-2378 for a Return Merchandise Authorization (RMA) number. A 15% re-stocking fee will be applied. Include a copy of your invoice or packing slip with your return.

DAMAGED OR LOST SHIPMENTS

All shipments: Check your order immediately upon arrival. All damage must be noted on the delivery receipt. Call Stenner Customer Service at 800-683-2378 for all shortages and damages within seven (7) days of receipt.

DISCLAIMER

The information contained in this manual is not intended for specific application purposes. Stenner Pump Company reserves the right to make changes to prices, products, and specifications at any time without prior notice.

SAFETY INFORMATION

 **⚠ WARNING** Warns about hazards that **CAN** cause death, serious personal injury, or property damage if ignored.

 **⚠ WARNING** This information contained in this manual is for reference only. Prior to beginning any water treatment regimen, always consult with a water treatment professional and adhere to the information contained in the chemical manufacturer's Material Safety Data Sheet.

 **⚠ WARNING** **ELECTRIC SHOCK HAZARD:** Equipment is supplied with grounding power cord and attached plug. To reduce risk of electrical shock, connect only to a properly grounded, grounding type receptacle. Install only on a circuit protected by a Ground-Fault Circuit-Interrupter (GFCI).

 **⚠ DO NOT** alter the power cord or plug end.

 **⚠ DO NOT** use receptacle adapters.

 **⚠ DO NOT** use PCM with a damaged or altered power cord or plug. Contact the factory for repair.

 **ELECTRIC SHOCK HAZARD**

 **⚠ WARNING** **HAZARDOUS VOLTAGE:** **DISCONNECT** power cord before removing cover for service. **Electrical service by trained personnel only.**

 **⚠ WARNING** **EXPLOSION HAZARD:** This equipment **IS NOT** explosion proof. **DO NOT** install or operate in an explosive environment.





 **⚠ WARNING** **RISK OF FIRE HAZARD:** **DO NOT** install or operate on any flammable surface.

 **⚠ CAUTION** Warns about hazards that **WILL** or **CAN** cause minor personal injury or property damage if ignored.

 **⚠ CAUTION** Final settings on Stenner Metering Pumps or Pump Control Modules must be determined through analytical testing of the treated water. The formulas contained herein are intended solely as a guide to be used to assist in the proper application of Stenner Pumps. The Stenner Pump Company makes no guarantee as to the accuracy of the information contained herein. User assumes all risk and liability from use of the information contained in this manual.

SAFETY INFORMATION continued

 **NOTICE: Indicates special instructions or general mandatory action.**

-  **DO** read all product manuals for proper safety and complete operation instructions.
-  **DO NOT** attempt installation or service prior to reading and understanding all safety hazards. This equipment is designed for installation and service by trained personnel.
-  **DO** install PCM so that it is in compliance with all national and local codes.
-  **DO** use all required personal protective equipment when working on or near chemical metering pumps.

 **This is the safety alert symbol. When displayed in this manual or on the equipment, look for one of the following signal words alerting you to the potential for personal injury or property damage.**

 **PCM INTENDED FOR INDOOR USE.**

 Electrical installation should adhere to all national and local codes. Consult a licensed professional for assistance with proper electrical installation.

SPECIFICATIONS

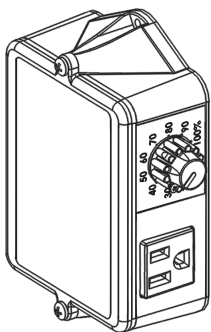

HOUSING

Polycarbonate

TIMER

Microcontroller with triac output

TURNDOWN RATIO

10:1

INPUT SIGNAL

Non-voltage dry contact water meter

RESET TIME

Immediate

MINIMUM SIGNAL DURATION

10 milliseconds

INPUT ELECTRICAL

120V 60Hz

MAXIMUM LOAD

1.8 A @ 120V 60Hz/216 V-A

NO LOAD CURRENT

0.45mA AC maximum

SHIPPING WEIGHT

2 lbs (0.9 kg)

BOX DIMENSIONS

8 x 8 x 6 in. (20.3 x 20.3 x 15.2 cm)

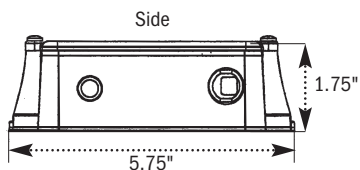
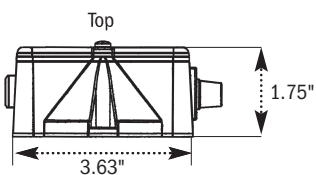
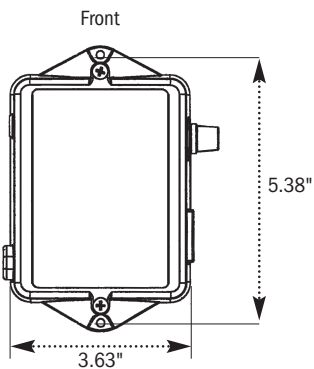

SIZING

PRE-SIZING REQUIREMENTS

- Maximum system flow rate or well pump flow rate in gallons per minute (gpm)
- Dosage in parts per million (ppm)
- Solution strength in parts per million (ppm)
- Water meter contacts per gallon (cpg or ppg)
- Stenner fixed output metering pump

Key

cpg	contacts per gallon
ppg	pulse per gallon
ppm	parts per million
gpm	gallons per minute
gpd	gallons per day
spg	seconds per gallon
min.	minute
sec.	second

SIZING continued

1. Determine the **MAXIMUM SYSTEM FLOW RATE OR WELL PUMP FLOW RATE** in gallons per minute (gpm).

If well pump output is unknown, refer to example below:

Calculate well pump output rate (gpm).

Determine the output rate by opening a faucet until the well pump turns on. Immediately turn off the faucet and time how long the well pump runs. Next, measure the volume of water drawn from the faucet until the well pump turns on again.

$$\frac{\text{volume of water until the pump turns on (gal.)}}{\text{how long the pump runs (min.)}} = \frac{\text{Well Pump Output Rate (gpm)}}{\text{Rate (gpm)}}$$

Example: After drawing 10 gallons of water, the well pump took 2 minutes to fill the pressure tank and stop.

$$\frac{10 \text{ gallons}}{2 \text{ minutes}} = 5 \text{ gpm}$$

2. Determine **SOLUTION STRENGTH (%) and DOSAGE** requirement (ppm).

If dosage is unknown, refer to example below:

Calculate required dosage (ppm).

Refer to Oxidation Rates below. Estimate dosage and include the ppm of required residual.

Example: To treat a water supply containing 2 ppm iron and 4 ppm hydrogen sulfide with a chlorine residual of 1 ppm, a dosage 15 ppm of chlorine is required.

$$\begin{aligned} 2 \text{ ppm iron} \times 1 \text{ ppm chlorine} &= 2 \\ 4 \text{ ppm hydrogen sulfide} \times 3 \text{ ppm chlorine} &= 12 \\ 1 \text{ ppm chlorine residual} &= 1 \\ \text{Total } 2 + 12 + 1 &= 15 \text{ ppm} \end{aligned}$$

COMMON CHEMICAL SOLUTION STRENGTHS IN ppm

NAME	%	ppm
Sodium Hypochlorite	5.25	52,500
	6.125	61,250
	12.5	125,000
Potassium Permanganate Dissolved at 1/4 lb per gallon	3	30,000
Hydrogen Peroxide	7	70,000
Polyphosphate Dissolved at 1/4 lb per 10 gallons	1.2	12,000

OXIDATION RATES

For each ppm of	IRON	MANGANESE	HYDROGEN SULFIDE
Required ppm of CHLORINE	1	2	3
Required ppm of HYDROGEN PEROXIDE	0.5	1	1.5

SIZING continued

3. Determine METERING PUMP OUTPUT requirement.

Calculate the pump output based on maximum flow rate determined in #1, solution strength & dosage in #2 and the formula below.

$$\frac{\text{Flow Rate (gpm)} \times \text{Dosage (ppm)} \times 1440}{\text{Solution Strength ppm}^*} = \text{Metering Pump Output (gpd)}$$

* Solution Strength % x 10,000 = Solution Strength ppm

4. Select PUMP.

Select a fixed output pump with maximum output (gpd) that slightly exceeds pump output requirement determined in #3.

STENNER PUMP MODELS (up to 100 psi)

FIXED OUTPUT	PUMP TUBE	MAXIMUM OUTPUT (gpd)
45MPHP2	#1	3
45MPHP10	#2	10
45MPHP22	#7	22
85MPHP5	#1	5
85MPHP17	#2	17
85MPHP40	#7	40

SIZING continued

5. Determine the AVAILABLE DOSE TIME in seconds.

The Available Dose Time is the minimum time interval between water meter contact closures. Each closure sends an input signal to the PCM.

$$a. \frac{60}{\text{Maximum System Flow Rate (gpm)}} = \text{Maximum System Flow Rate (spg)}$$

$$b. \frac{\text{Maximum System Flow Rate (spg)}}{\text{Water Meter's contacts per gallon (cpg)}^*} = \text{Available Dose Time (sec.)}$$

* Refer to the water meter model number to confirm the contact rate (cpg).

6. Determine the PCM OPERATING TIME in seconds.

Calculate the PCM Operating Time based on pump selection in #4, solution and dosage in #2 and use the formula below.

$$\frac{\text{Pump Output Requirement (gpd)} \times \text{Available Dose Time}}{\text{Selected Pump's Maximum Output (gpd)}} = \text{PCM Operating Time (sec.)}$$



▲ WARNING **PCM OPERATING TIME EXCEEDING AVAILABLE DOSE TIME MAY LEAD TO DOSING ERRORS.** To reduce PCM Operating Time, select a pump with a higher output or use stronger solution strength.

SIZING continued

- 7. Select PCM MODEL based on PCM Operating Time determined in #6, refer to the chart below.**

PCM MODELS

MODEL	OPERATING RANGE* (SECONDS)
PCM1	0.1 to 1.0
PCM5	0.5 to 5.0
PCM10	1.0 to 10.0
PCM20	2.0 to 20.0

* Factory preset.

⚠ WARNING **PCM OPERATING TIME EXCEEDING AVAILABLE DOSE TIME MAY LEAD TO DOSING ERRORS.** To reduce PCM Operating Time, select a pump with a higher output or use stronger solution strength.

- 8. Determine PCM SETTING PERCENTAGE.**

$$\frac{\text{PCM Operating Time (sec.)}}{\text{Maximum PCM Operating Time (sec.)}^{**}} \times 100 = \text{PCM Setting \%}$$

** Value can only be 1, 5, 10 or 20

Turn the PCM knob to adjust to the percentage setting calculated. Use the locking screw located on the PCM knob to secure it.

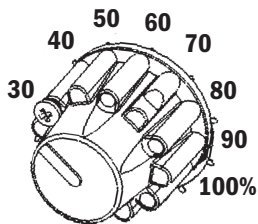

INSTALLATION

- ❗ **Mount PCM in a dry location to avoid water intrusion and damage.**
 1. Position the PCM within 6 feet of the Stenner fixed output metering pump and mount to a suitable surface using adequate fasteners through the mounting holes.
- ❗ **Check supply voltage prior to connecting power cord to prevent damage. The use of a GFCI circuit is recommended.**
 2. Uncoil the input signal cable and remove approximately 2 inches of the outer cable jacket.
- ❗ **DO NOT connect PCM input signal cord to any AC voltage supply.**
- ❗ **DO NOT connect PCM input signal cord to any hall effect, 4-20mA or voltage carrying signal source.**
 3. Strip the ends of the two wires within the cable approximately one-half inch.
- ❗ **Use PCM only with a dry contact, reed switch style water meter.**
 4. Attach the two wires to the contact output water meter or relay switch.
 5. Adjust the knob to the desired on-time duration. Refer to the “Sizing” in this manual for assistance.
- ❗ **If using an adjustable metering pump, it is recommended that the pump be set at 100%.**
 6. With necessary suction, discharge and point of injection connections secured, prime the pump by plugging it into a 120V receptacle and turning on the power switch.
 7. Unplug the fixed output metering pump’s power cord from receptacle and plug into the PCM’s receptacle.
 8. Plug the PCM power cord into a properly grounded, 120V receptacle.

INSTALLATION DIAGRAM

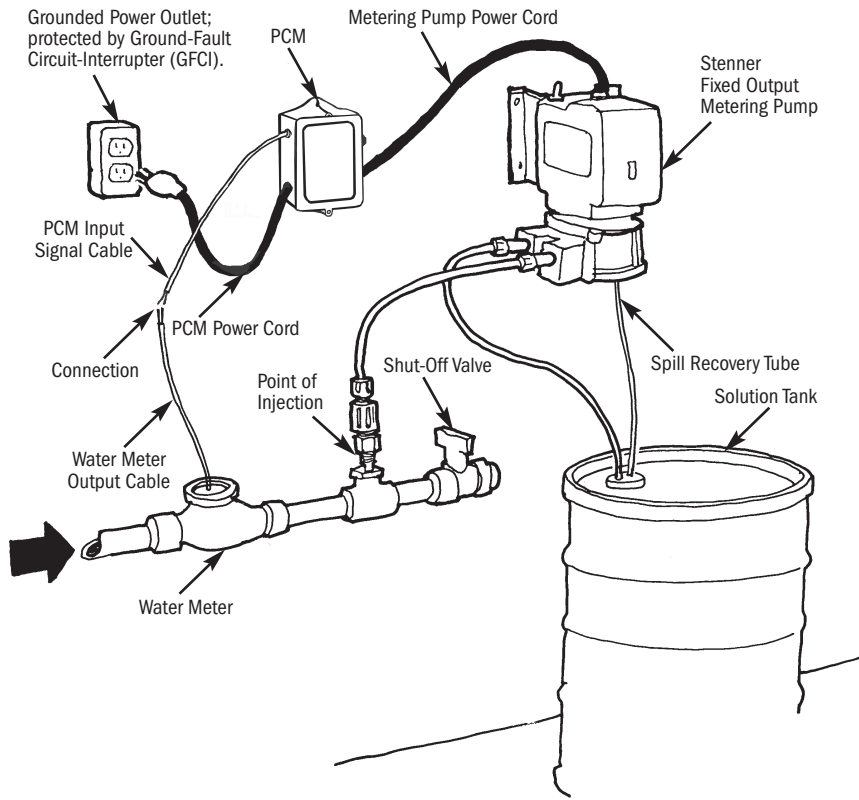

TROUBLESHOOTING

LACK OF INPUT SUPPLY VOLTAGE (120V)

Plug the fixed output chemical metering pump directly into the 120V receptacle into which the PCM was originally plugged. This will bypass the PCM. If the pump does not run the power source or pump is defective. If the metering pump operates proceed to *LACK OF PROPER INPUT SIGNAL*.

LACK OF PROPER INPUT SIGNAL

Plug the metering pump into the PCM and the PCM into the receptacle tested in *Step 1*. Remove the PCM input signal cable from the water meter or relay and touch the two wires together. The pump should operate for the pre-determined run time setting and then stop.

- If the metering pump runs, the failure is in the water meter contacts.
- If the metering pump does not run the failure is in the PCM.
- Contact the factory for information on service and repair.

PCM OPERATING RANGE CONVERSION

⚠ WARNING HAZARDOUS VOLTAGE:
DISCONNECT power cord before removing cover for service. **Electrical service by trained personnel only.**

The PCM operating range is factory set according to the specific model. The operating range can be changed to convert a PCM to any of four available operating ranges without purchasing another model.

The operating range is converted by changing the position of the jumpers on the printed circuit board located under the PCM's cover. *Illustration A.* The PCM is equipped with two jumpers that are positioned over the pins labeled 3, 2, 1. *Illustration B.*

To change the time range:

1. Unplug the PCM power cord from the input power supply.
2. Remove the cover and reposition the jumpers to correspond with the desired operating range. Refer to *Interchangeable Operating Range Settings* below.
3. Replace the PCM cover.
4. **IMPORTANT!** Update the PCM data label to represent the converted model and operating range for accurate sizing.

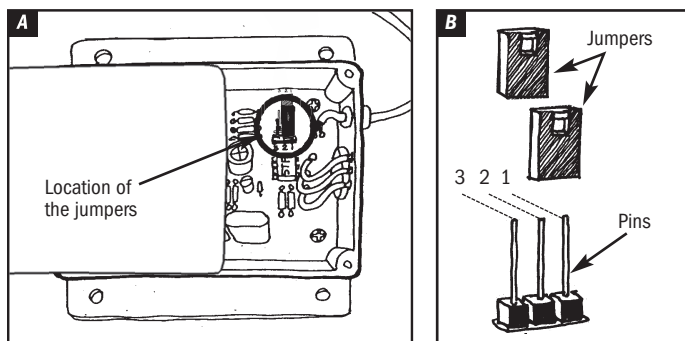

INTERCHANGEABLE OPERATING RANGE SETTINGS

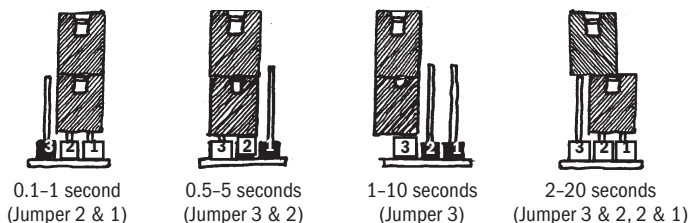



STENNER PUMP COMPANY

3174 DeSalvo Road
Jacksonville, Florida 32246

Phone: 904.641.1666

US Toll Free: 800.683.2378

Fax: 904.642.1012

sales@stenner.com

www.stenner.com

Hours of Operation (EST):

Mon.-Thu. 7:30 am-5:30 pm

Fri. 7:00 am-5:30 pm

 Stenner products are proudly made in the USA

© Stenner Pump Company
All Rights Reserved