



**PCM SERIES** PUMP CONTROL MODULE  
INSTALLATION AND MAINTENANCE MANUAL

---

PERISTALTIC METERING PUMPS SINCE 1957

# **TABLE OF CONTENTS**

<b>WARRANTY AND SERVICE POLICY .....</b>	<b>3</b>
<b>SAFETY INFORMATION .....</b>	<b>4-5</b>
<b>SPECIFICATIONS.....</b>	<b>6</b>
<b>PCM AND PUMP SIZING.....</b>	<b>7-11</b>
<b>INSTALLATION.....</b>	<b>12-13</b>
<b>TROUBLESHOOTING.....</b>	<b>14</b>
<b>PCM MODEL CONVERSION .....</b>	<b>15</b>

PCM209

# WARRANTY AND CUSTOMER SERVICE

## LIMITED WARRANTY

Stenner Pump Company will for a period of one (1) year from the date of purchase (proof of purchase required) repair or replace – at our option – all defective parts. Stenner Pump Company is not responsible for any removal or installation costs. Stenner Pump Company will incur shipping costs for warranty products shipped from our factory in Jacksonville, Florida. Any tampering with major components, chemical damage, faulty wiring, weather conditions, power surges, or products not used with reasonable care and maintained in accordance with the instructions will void the warranty. Stenner Pump Company limits its liability solely to the cost of the original product. We make no other warranty expressed or implied.

## RETURNS

Stenner offers a 30-day return policy. Except as otherwise provided, no material will be accepted for return after 30 days from purchase. To return merchandise at any time, call Stenner at 800-683-2378 for a Return Merchandise Authorization (RMA) number. A 15% re-stocking fee will be applied. Include a copy of your invoice or packing slip with your return.

## DAMAGED OR LOST SHIPMENTS

UPS and prepaid truck shipments: Check your order immediately upon arrival. All damage must be noted on the delivery receipt. Call Stenner Customer Service at 800-683-2378 for all shortages and damages within seven (7) days of receipt.

## DISCLAIMER

The information contained in this manual is not intended for specific application purposes. Stenner Pump Company reserves the right to make changes to prices, products, and specifications at any time without prior notice.

# SAFETY INFORMATION



**WARNING** Warns about hazards that **CAN** cause death, serious personal injury, or property damage if ignored.



**WARNING** **ELECTRIC SHOCK HAZARD:**

Equipment is supplied with grounding power cord and attached plug. To reduce risk of electrical shock, connect only to a properly grounded, grounding type receptacle.



**DO NOT** alter the power cord or plug end.



**DO NOT** use receptacle adapters.



**DO NOT** use PCM with a damaged or altered power cord or plug. Contact the factory for repair.



**ELECTRIC SHOCK HAZARD**



**WARNING** **HAZARDOUS VOLTAGE:**

**DISCONNECT** power cord before removing cover for service. **Electrical service by trained personnel only.**



**WARNING** **EXPLOSION HAZARD:**

This equipment **IS NOT** explosion proof. **DO NOT** install or operate in an explosive environment.







**WARNING** **RISK OF FIRE HAZARD:**

**DO NOT** install or operate on any flammable surface.

# SAFETY INFORMATION continued

 **NOTICE:** Indicates special instructions or general mandatory action.

-  **DO NOT** attempt installation or service prior to reading and understanding all safety hazards. This equipment is designed for installation and service by trained personnel.
-  **DO** install PCM so that it is in compliance with all national and local codes.
-  **DO** use all required personal protective equipment when working on or near chemical metering pumps.

 **This is the safety alert symbol. When displayed in this manual or on the equipment, look for one of the following signal words alerting you to the potential for personal injury or property damage.**

 **PCM INTENDED FOR INDOOR USE.**

 Electrical installation should adhere to all national and local codes. Consult a licensed professional for assistance with proper electrical installation.

# SPECIFICATIONS

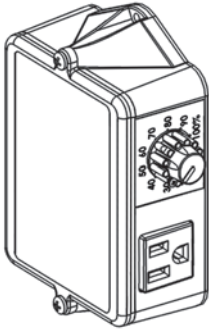

Front

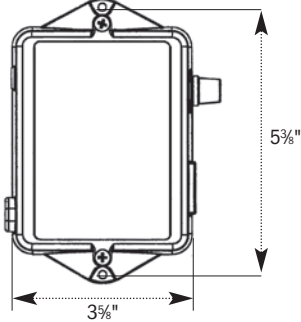

Top

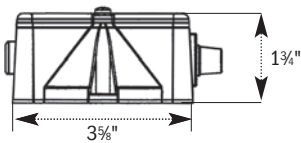

Side

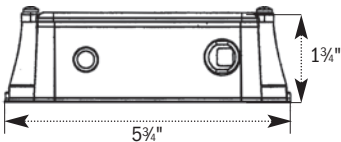

## HOUSING

Polycarbonate plastic

## TIMER

Microcontroller with triac output

## TURNDOWN RATIO

10:1

## INPUT SIGNAL

Non-voltage dry contact water meter

## TIME RANGE

Interchangeability located inside PCM

## RESET TIME

Immediate

## MINIMUM SIGNAL DURATION

10 milliseconds

## INPUT ELECTRICAL

120V 60Hz

## NO LOAD CURRENT

0.45mA AC maximum

## AMP DRAW @ MAXIMUM LOAD

1.8 @ 120V 60Hz

## SHIPPING WEIGHT

2 lbs (1 kg)

## BOX DIMENSIONS

8 x 8 x 6 in. (20.3 x 20.3 x 15.2 cm)

# PCM AND PUMP SIZING

## PRE-SIZING REQUIREMENTS

- Maximum flow rate (of the water system) in gallons per minute (gpm)
- Required dose amount in parts per million (ppm)
- Solution strength in parts per million (ppm)
- Water meter contacts per gallon (cpg or ppg)
- Stenner fixed output metering pump

### Key

cpg	contacts per gallon
ppg	pulse per gallon
ppm	parts per million
gpm	gallons per minute
gpd	gallons per day
gps	gallons per second
spg	seconds per gallon

# PCM AND PUMP SIZING continued

## I. DETERMINE AVAILABLE DOSE TIME

The available dose time is the minimum time interval (seconds) between the water meter contact closures during the maximum system flow rate. Each closure sends an input signal to the PCM.

**!** **DO NOT** adjust the PCM time to a longer duration than the minimum time between water meter contacts.

The available dose time is calculated using two equations:

1. Convert maximum system flow rate in gallons per minute to seconds per gallon. Divide 60 seconds by the gallons per minute.

$$\text{spg} = \frac{60 \text{ seconds}}{\text{gpm}}$$

2. Determine the minimum time between meter contact closures in seconds. Divide the maximum system flow rate in seconds per gallon by the meter's contacts per gallon.

$$\text{Available dose time (sec)} = \frac{\text{spg}}{\text{cpg}}$$

# PCM AND PUMP SIZING continued

## II. CALCULATE THE PUMP OUTPUT REQUIREMENT IN GALLONS PER DAY

The pump output requirement in gallons per day is based upon the maximum flow rate of the system in gallons per minute, dosage requirement and the solution strength in parts per million. Refer to the chart for common solution strengths in ppm.

To calculate the pump output requirement, use the following equation:

$$\text{Pump output requirement (gpd)} = \frac{\text{Maximum system flow rate (gpm)} \times \text{Dosage requirement (ppm)} \times 1440}{\text{Solution strength (ppm)}}$$

### Common Chemical Solution Strengths

NAME	STRENGTH %	STRENGTH PPM
Sodium Hypochlorite	5.25	52,500
	6.125	61,250
	12.5	125,000
Potassium Permanganate Dissolved at 1/4 lb per gallon	3	30,000
Hydrogen Peroxide	7	70,000
Polyphosphate Dissolved at 1/4 lb per 10 gallons	1.2	12,000

# PCM AND PUMP SIZING continued

### III. SELECT A PUMP MODEL

Refer to the chart to select a fixed output pump with a maximum gpd that slightly exceeds the pump output requirement (gpd) as determined in *Step II*.

### IV. DETERMINE FEED TIME DURATION IN SECONDS

To calculate the feed time duration in seconds, divide the pump output requirement (gpd) determined in *Step II* by the selected pump's maximum output (gpd) determined in *Step III* and multiply by the available dose time (seconds) calculated in *Step I*.

$$\text{Feed time duration (sec)} = \frac{\text{Pump output requirement (gpd)}}{\text{Selected pump's max. output (gpd)}} \times \text{Available dose time}$$

**!** **NOTICE: DO NOT** adjust the PCM to run longer than the available dose time (*Step I*). Failure to maintain this relationship will result in chemical feed errors. The PCM is designed for use with a fixed output metering pump. Stenner's adjustable pump should be used at the maximum output setting when used with the PCM.

### Stenner Fixed Output Pumps

MODEL	MAXIMUM GPD
45MPHP2	3
45MPHP10	10
45MPHP22	22
85MPHP5	5
85MPHP17	17
85MPHP40	40

# PCM AND PUMP SIZING continued

## V. SELECT PCM MODEL AND DETERMINE SETTING

1. Refer to the chart to select the PCM model based on the feed time duration.
2. To determine the PCM percentage setting, divide the feed time (seconds) calculated in *Step IV* by the PCM's maximum time (seconds) and multiply by 100.

$$\text{PCM setting (\%)} = \frac{\text{Required feed time (sec)}}{\text{PCM max. time (sec)}} \times 100$$

3. Turn the PCM knob to adjust to the percentage setting calculated. Use the locking screw located on the PCM knob to secure it.

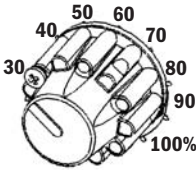

**!** **FINAL PCM SETTINGS** must be determined through analytical testing of the water. The procedure and formulas contained herein are intended solely as a guide to be used to assist in the proper application of Stenner's PCM (Pump Control Module). Stenner Pump Company makes no guarantee as to the accuracy of the information contained herein. User assumes all risk and liability from use of the information contained in this manual.

### PCM Models

MODEL	TIME RANGE (SECONDS)
PCM1	0.1 to 1.0
PCM5	0.5 to 5.0
PCM10	1.0 to 10.0
PCM20	2.0 to 20.0

Time ranges are factory preset.

# INSTALLATION

- ❗ **Mount PCM in a dry location to avoid water intrusion and damage.**
  1. Position the PCM within 6 feet of the Stenner fixed output metering pump and mount to a suitable surface using adequate fasteners through the mounting holes.
- ❗ **Check supply voltage prior to connecting power cord to prevent damage. The use of a GFCI circuit is recommended.**
  2. Uncoil the input signal cable and remove approximately 2 inches of the outer cable jacket.
- ❗ **DO NOT connect PCM input signal cord to any AC voltage supply.**
- ❗ **DO NOT connect PCM input signal cord to any hall effect, 4-20mA or voltage carrying signal source.**
  3. Strip the ends of the two wires within the cable approximately one-half inch.
- ❗ **Use PCM only with a dry contact, reed switch style water meter.**
  4. Attach the two wires to the contact output water meter or relay switch.
  5. Adjust the knob to the desired on-time duration. Refer to the “PCM and Pump Sizing” in this manual for assistance.
- ❗ **If using an adjustable metering pump, it is recommended that the pump be set at 100%.**
  6. With necessary suction, discharge and point of injection connections secured, prime the pump by plugging it into a 120V receptacle and turning on the power switch.
  7. Unplug the fixed output metering pump’s power cord from receptacle and plug into the PCM’s receptacle.
  8. Plug the PCM power cord into a properly grounded, 120V receptacle.

# INSTALLATION DIAGRAM

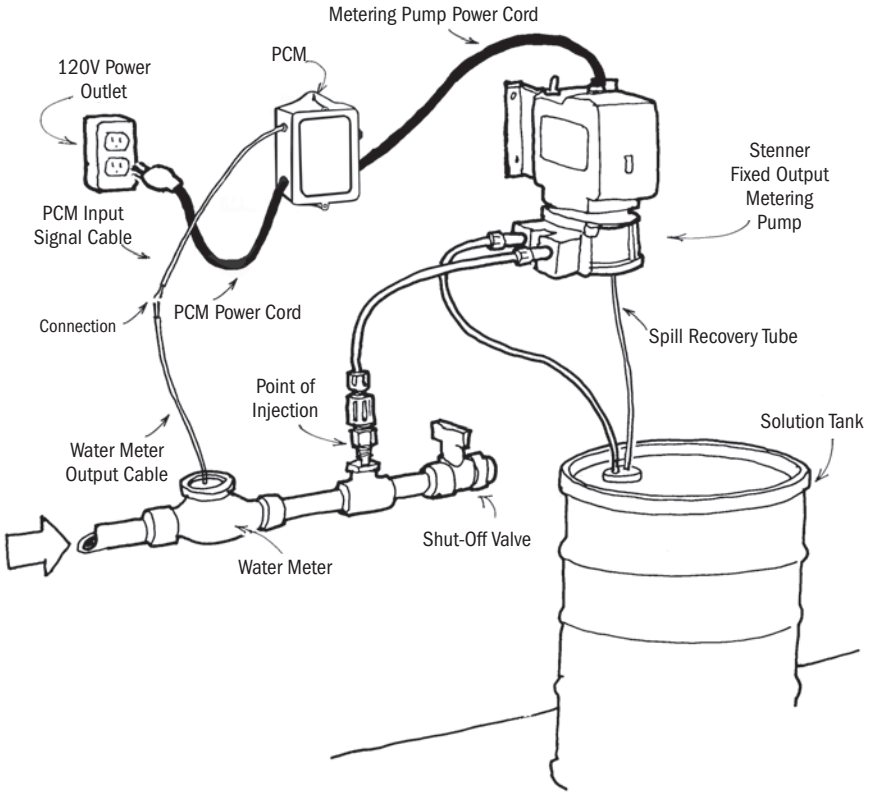

# TROUBLESHOOTING

## **LACK OF INPUT SUPPLY VOLTAGE (120V)**

Plug the fixed output chemical metering pump directly into the 120V receptacle into which the PCM was originally plugged. This will bypass the PCM. If the pump does not run the power source or pump is defective. If the metering pump operates proceed to *LACK OF PROPER INPUT SIGNAL*.

## **LACK OF PROPER INPUT SIGNAL**

Plug the metering pump into the PCM and the PCM into the receptacle tested in *Step 1*. Remove the PCM input signal cable from the water meter or relay and touch the two wires together. The pump should operate for the pre-determined run time setting and then stop.

- If the metering pump runs, the failure is in the water meter contacts.
- If the metering pump does not run the failure is in the PCM.
- Contact the factory for information on service and repair.

# PCM MODEL CONVERSION



## **WARNING** HAZARDOUS VOLTAGE:

**DISCONNECT** power cord before removing cover for service. **Electrical service by trained personnel only.**

The PCM time range is factory set according to the specific model. The time range can be changed to convert a PCM to any of four available time ranges without purchasing another model.

The time range is converted by changing the position of the jumpers on the printed circuit board located under the PCM's cover. *Illustration A.* The PCM is equipped with two jumpers that are positioned over the pins labeled 3, 2, 1. *Illustration B.*

To change the time range:

1. Unplug the PCM power cord from the input power supply.
2. Remove the cover and reposition the jumpers to correspond with the desired time range. See chart.
3. Replace the PCM cover.
4. **IMPORTANT!** Update the PCM data label to represent the converted model and time range for accurate sizing.

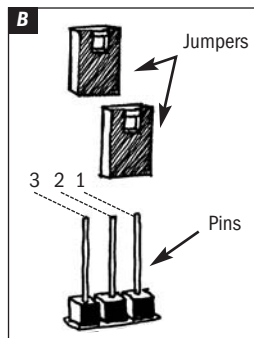
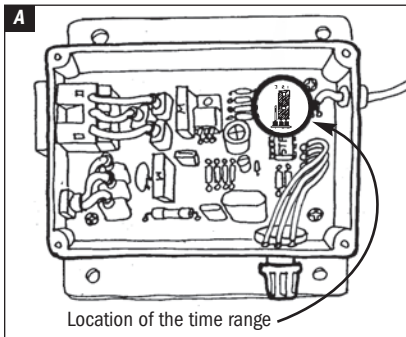

## INTERCHANGEABLE TIME RANGE SETTINGS



0.1-1 second  
(Jumper 2 & 1)



0.5-5 seconds  
(Jumper 3 & 2)

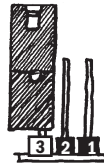

1-10 seconds  
(Jumper 3)

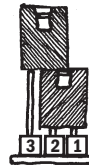

2-20 seconds  
(Jumper 3 & 2, 2 & 1)



## **STENNER PUMP COMPANY**

3174 DeSalvo Road  
Jacksonville, Florida 32246

Phone: 904.641.1666  
US Toll Free: 800.683.2378  
Fax: 904.642.1012

[sales@stenner.com](mailto:sales@stenner.com)  
[www.stenner.com](http://www.stenner.com)

Hours of Operation (EST):  
Mon.-Thu. 7:30 am-5:30 pm  
Fri. 7:00 am-5:30 pm

 Stenner products are proudly made in the USA

© Stenner Pump Company  
All Rights Reserved